

QUEEN

Un design ricco e originale, una seduta con doppio cuscino che ne esalta bellezza e comfort, la possibilità di inserimento della meccanica relax elettrica sia sulla seduta che sul poggiatesta lo rendono un divano unico e tutto da vivere.

A rich and original design, with double pillow seats that enhance the beauty and comfort. An option is to put the motorised recliner into the seats and the headrest to make it an unique sofa that has to be experienced.

Un design original, une assise avec double coussin qui en exalte beauté et confort. La possibilité d'intégrer de la relaxation dans les assises et les têtes pour faire un canapé unique et séduisant.





COMPOSIZIONE C1 . L. 292 x P. 167 H. 83/109 cm _ VALERY POLTRONA . L. 72 P. 80 H. 75 cm

QUEEN / 7



ACCOMODATEVI
IN UN MONDO
DI RELAX
E DESIGN



DIVANO 3 POSTI . L. 216 P. 100 H. 83/109 cm



QUEEN fisso/relax . fixed/relax . fixe/relax

STRUTTURA

Struttura in multistrato di legno e altri derivati del legno

IMBOTTITURA

Poliuretano espanso a densità differenziate e falda di ovatta acrilica
 Seduta:
 densità 35 kg x m³
 Spalliera:
 densità 21 kg x m³

SOSPENSIONE SEDUTA

Cinghie elastiche ad alta resistenza

RIVESTIMENTO

Tessuto:
 completamente sfoderabile
 Ecopelle:
 parzialmente sfoderabile
 Pelle:
 non sfoderabile

OPTIONAL

- relax elettrico
 - poggiatesta reclinabile elettrico

STRUCTURE

Framework in poplar, fir and various derivatives

UPHOLSTERY

Polyurethane foam - various densities + acrylic wadding
 Seats:
 density 35 kg x m³
 Backrest:
 density 21 kg x m³

SEAT SUPPORT

High strength elastic straps

COVERING

Fabric:
 fully removable
 Artificial leather:
 partially removable
 Bonded leather:
 not removable

OPTIONAL EXTRA

- relax electric
 - electric reclining headrest

STRUCTURE

Sapin peuplier, multiplis et panneaux de particules

GARNISSAGE

Mousse polyuréthane expansé haute résilience
 Assises:
 densité 35 kg x m³ + couche acrylique
 Dossier:
 densité 21 kg x m³ + couche acrylique

SUSPENSION D'ASSISE

Sangles élastiques haute résistance

REVETEMENT

Tissu:
 totalement déhoussable
 PVC:
 partiellement déhoussable
 Cuir:
 non déhoussable

OPTIONS

- relax électrique
 - têtes réglables électriques



poltrona . divano / armchair . sofa / fauteuil . canapé

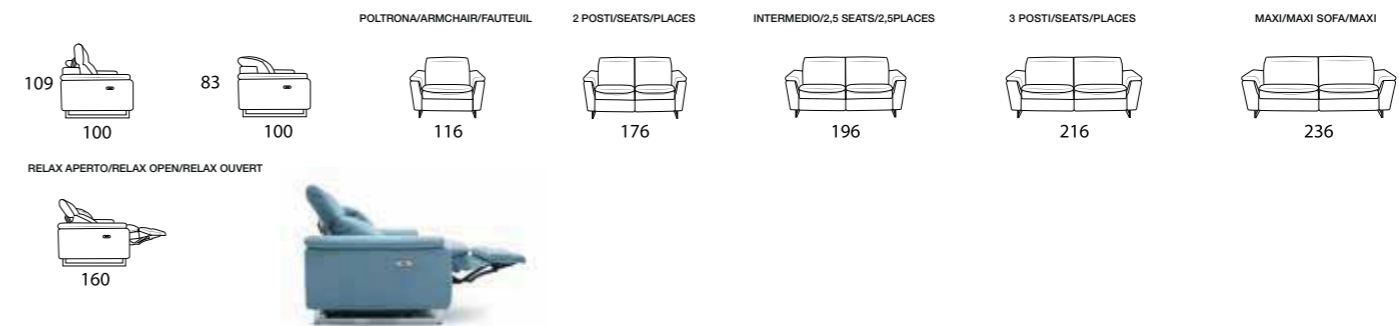

laterale sx-dx / element left-right / élément gauche-droite

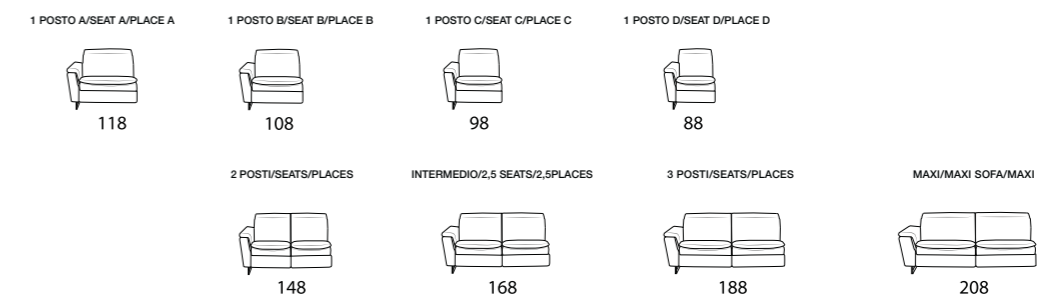

chaise longue sx-dx / chaise longue left-right / chaise longue gauche-droite

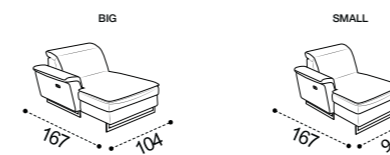

pouff / ottoman / pouf

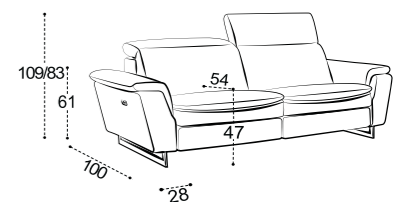
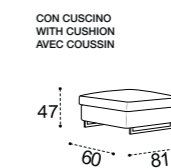

composizione C1 composition C1 composition C1

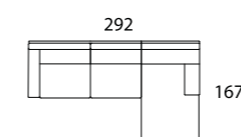

laterale 3PS fisso+chaise longue big
 3PLCS side sofa+lounge chair big
 terminal 3PL+chaise longue big

composizione full optional composition full optional composition full optional

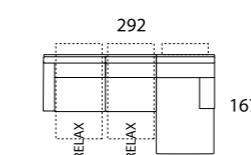

laterale 3PS+chaise longue big+2 relax+3 poggiatesta reclinabili elettrici
 3PLCS side sofa+lounge chair big+2 relax+3 electric reclining headrest
 terminal 3PL+chaise longue big+2 relax+3 têtes réglables électriques

specificare lato chaise longue destra o sinistra
 to specify right or left chaise-longue
 spécifier si chaise-longue droite ou gauche

GENESIS

Forme uniche, eleganti, sapientemente coordinate in un equilibrio di raffinatezza e modernità, pensato per un pubblico esigente e attento ai particolari. Un'attenzione notevole al comfort che anche grazie al poggiatesta reclinabile raggiunge livelli davvero eccezionali. Disponibile in vera pelle e in tessuto, nella versione fisso, letto e con relax elettrico.

Uniquely elegant and nicely balanced shapes for a demanding public. Special attention is given to the comfort, which, with the reclining headrests, reaches remarkable levels. Available in leather and fabric, both bed and fixed versions and with motorised recliner.

Une forme unique, élégante tant par son équilibre de raffinement que par sa modernité, étudiée pour un public exigeant et attentif aux détails. Ses têtes réglables apportent un confort supplémentaire de relaxation. Disponible en cuir et en tissu, en version fixe, avec relaxation électrique et en convertible.







QUI COMFORT E RELAX TROVANO SEMPRE POSTO



COMPOSIZIONE C4 . L. 264 x P. 167 H. 88/110 cm

GENESIS / 19



DIVANO 3 POSTI . L. 212 P. 100 H. 88/110 cm

APERTO
A TUTTE LE
VOSTRE
ESIGENZE
DI RIPOSO



GENESIS letto . bed . lit

Divano letto trasformabile con rete elettrosaldata

MATERASSO DI SERIE
LUXURY H. 12 cm

MECCANISMO
Rete SPIDER

STRUTTURA
Metallica con parti esterne in pannelli di agglomerato di legno applicati con innesto a baionetta

IMBOTTITURA
Poliuretano espanso a densità differenziate e falda di ovatta acrilica
Seduta:
densità 35 kg x m³
Spalliera:
densità 21 kg x m³

SOSPENSIONE SEDUTA
Cinghie elastiche ad alta resistenza

RIVESTIMENTO
Tessuto:
completamente sfoderabile
Ecopelle:
parzialmente sfoderabile
Pelle:
non sfoderabile

Sofa bed with metal rigid electrowelded grid

MATTRESS STANDARD
LUXURY H. 12 cm

MECHANISM
SPIDER grid

STRUCTURE
Strong metallic structure, wooden particle boards with bayonet-joint

UPHOLSTERY
Polyurethane foam-various densities + acrylic wadding
Seats:
density 35 kg x m³
Backrest:
density 21 kg x m³

SEAT SUPPORT
High strength elastic straps

COVERING
Fabric:
fully removable
Artificial leather:
partially removable
Bonded leather:
not removable

Canapé lit transformable avec sommier e'lectrosoudé

MATELAS STANDARD
LUXURY H. 12 cm

MÉCANISME
Sommier SPIDER

STRUCTURE
Carcasse métallique, accoudoirs et bandeaux en contreplaqué, démontés à appliquer avec enclenchement à baionnette

GARNISSAGE
Mousse polyuréthane expansé haute résilience
Assises:
densité 35 kg x m³ + couche acrylique
Dossier:
densité 21 kg x m³ + couche acrylique

SUSPENSION D'ASSISE
Sangles élastiques haute résistance

REVELEMENT
Tissu:
totalement déhoussable
PVC:
partiellement déhoussable
Cuir:
non déhoussable

GENESIS fisso/relax . fixed/relax . fixe/relax

STRUTTURA
Struttura in multistrato di legno e altri derivati del legno

IMBOTTITURA
Poliuretano espanso a densità differenziate e falda di ovatta acrilica
Seduta:
densità 35 kg x m³
Spalliera:
densità 21 kg x m³

SOSPENSIONE SEDUTA
Cinghie elastiche ad alta resistenza

RIVESTIMENTO
Tessuto:
completamente sfoderabile
Ecopelle:
parzialmente sfoderabile
Pelle:
non sfoderabile

OPTIONAL
- relax elettrico
- batteria ricaricabile

STRUCTURE
Framework in poplar, fir and various derivatives

UPHOLSTERY
Polyurethane foam-various densities + acrylic wadding
Seats:
density 35 kg x m³
Backrest:
density 21 kg x m³

SEAT SUPPORT
High strength elastic straps

COVERING
Fabric:
fully removable
Artificial leather:
partially removable
Bonded leather:
not removable

OPTIONAL EXTRA
- motorised recliner
- rechargeable battery

STRUCTURE
Sapin peuplier, multiplis et panneaux de particules

GARNISSAGE
Mousse polyuréthane expansé haute résilience
Assises:
densité 35 kg x m³ + couche acrylique
Dossier:
densité 21 kg x m³ + couche acrylique

SUSPENSION D'ASSISE
Sangles élastiques haute résistance

REVELEMENT
Tissu:
totalement déhoussable
PVC:
partiellement déhoussable
Cuir:
non déhoussable

OPTIONS
- relax électrique
- batterie pour relax électrique

poltrona . divano / armchair . sofa / fauteuil . canapé

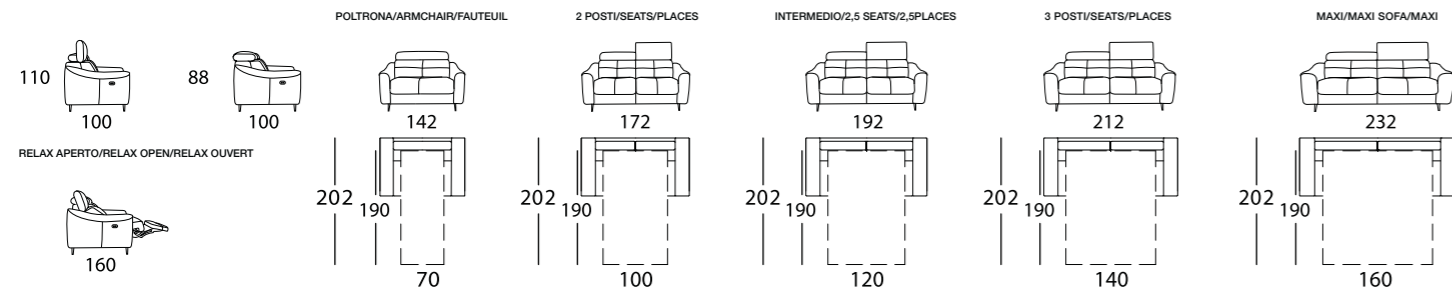

poltrona . divano / armchair . sofa / fauteuil . canapé

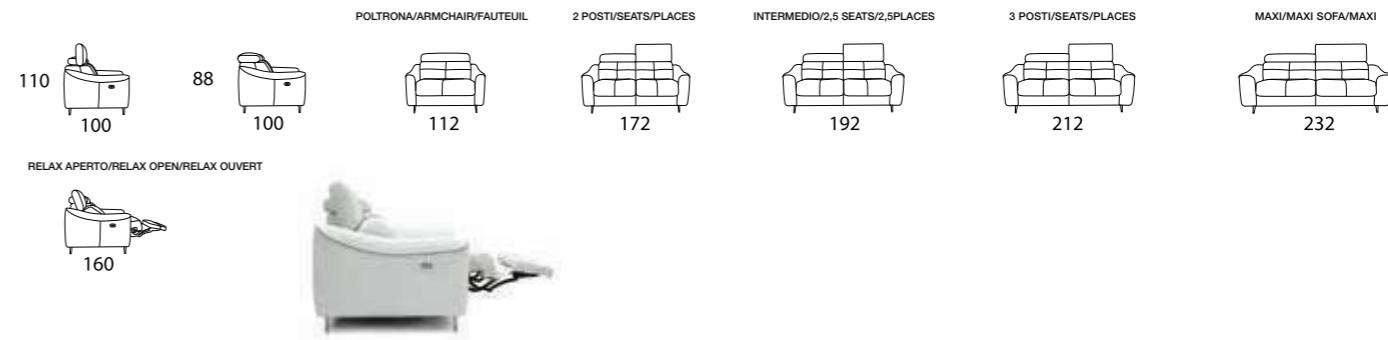

laterale sx-dx / element left-right / élément gauche-droite

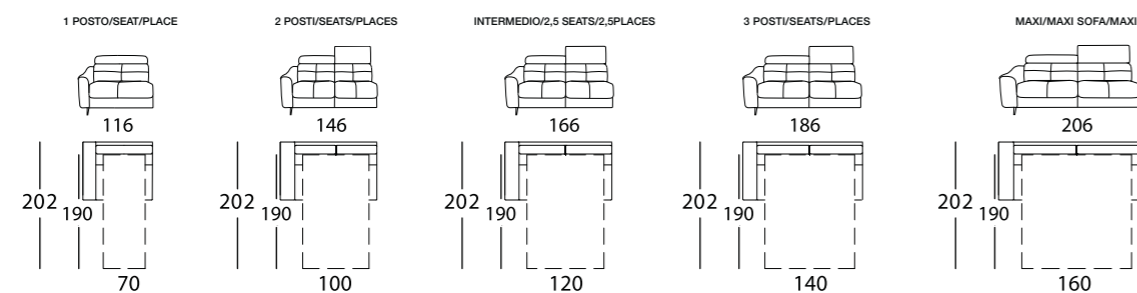

laterale sx-dx / element left-right / élément gauche-droite

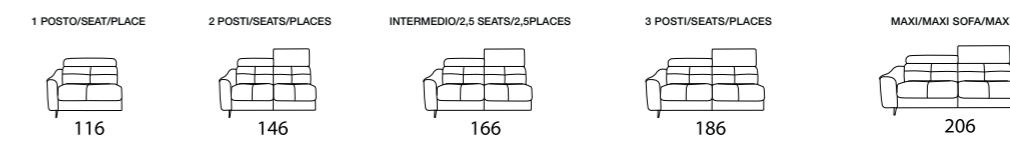

apertura divano / opening sofa / ouverture du canapé

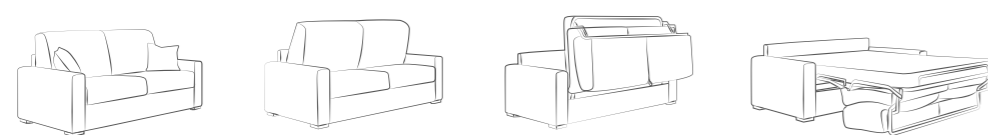

penisola sx-dx / corner peninsula left-right / angle meridienne gauche-droite

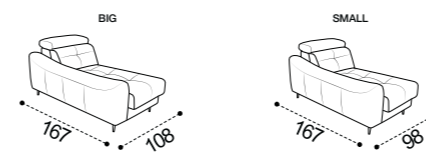

puoff / ottoman / pouf

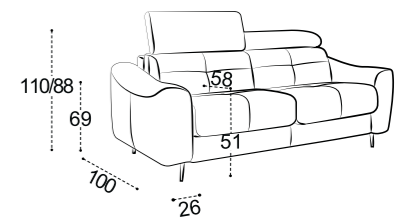
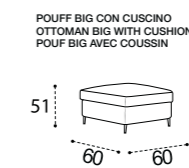

composizione C1 / composition C1 / composition C1

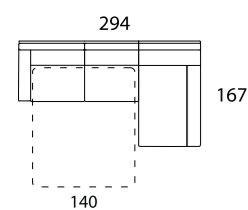

laterale 3PS letto+penisola big
3 PLCS side sofa+angle meridienne big
terminal 3PL lit+angle meridienne big

composizione C3 / composition C3 / composition C3

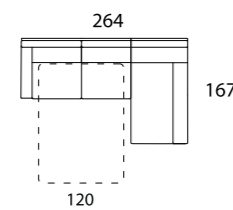

laterale intermedio letto+penisola small
2,5 PLCS side sofa+corner peninsula small
terminal 2,5 PL lit+angle meridienne small

specificare lato chaise longue destra o sinistra
to specify right or left chaise-longue
spécifier si chaise-longue droite ou gauche

composizione C1 / composition C1 / composition C1

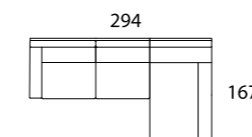

laterale 3PS fisso+penisola big
3 PLCS side sofa+corner peninsula big
terminal 3PL fixe+angle meridienne big

composizione C4 / composition C4 / composition C4

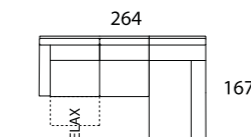

laterale intermedio fisso+penisola small+1 relax
2,5 PLCS side sofa+corner peninsula small+1 relax
terminal 2,5PL fixe+angle meridienne small+1 relax

specificare lato chaise longue destra o sinistra
to specify right or left chaise-longue
spécifier si chaise-longue droite ou gauche

VOGUE

Bellezza e comfort qui sono di casa. Lo schienale alto ed i braccioli sottili creano un contrasto davvero unico, e con le bordature a contrasto si può aggiungere un tocco di classe ed eleganza esclusivo. Disponibile nella versione fisso e letto con materasso h. 14 e 18 cm.

Beauty and comfort in one design. The high back and narrow arms create an unique contrast, and, with contrast piping, it is possible to add a touch of class and exclusive elegance. Available in fixed and bed version with 14cm or 18cm deep mattresses.

Charme et confort. Le dossier haut et les manchettes fines créent un contraste unique. Les passepoils à contraste pour une touche élégante. Disponible en version fixe et convertible avec matelas de 14 et 18cm.





COMPOSIZIONE C1 . L. 267 x P. 165 H. 110/114 cm





DIVANO 3 POSTI . L. 185 P. 110 H. 110/114 cm

VOGUE letto . bed . lit

Divano letto trasformabile con rete elettrosaldata

MATERASSO DI SERIE
LUXURY H. 14 cm

MECCANISMO
Rete SPIDER

STRUTTURA

Metallica con parti esterne in pannelli di agglomerato di legno applicati con innesto a baionetta

IMBOTTITURA

Poliuretano espanso a densità differenziate e falda di ovatta acrilica
Seduta:
densità 35 kg x m³
Spalliera:
densità 21 kg x m³

SOSPENSIONE SEDUTA

Cinghie elastiche ad alta resistenza

RIVESTIMENTO

Tessuto:
completamente sfoderabile
Ecopelle:
parzialmente sfoderabile

Disponibile anche con materasso H. 18 cm

Sofa bed with metal rigid electrowelded grid

MATTRESS STANDARD
LUXURY H. 14 cm

MECHANISM
SPIDER grid

STRUCTURE

Strong metallic structure, wooden particle boards with bayonet-joint

UPHOLSTERY

Polyurethane foam-various densities + acrylic wadding
Seats:
density 35 kg x m³
Backrest:
density 21 kg x m³

SEAT SUPPORT

High strength elastic straps

COVERING

Fabric:
fully removable
Artificial leather:
partially removable

Also available with mattress H. 18 cm

Canapé lit transformable avec sommier électrosoudé

MATELAS STANDARD
LUXURY H. 14 cm

MÉCANISME

Sommier SPIDER

STRUCTURE

Carcasse métallique, accoudoirs et bandeaux en contreplaqué, démontés à appliquer avec enclenchement à baionnette

GARNISSAGE

Mousse polyuréthane expansé haute résilience
Assises:
densité 35 kg x m³ + couche acrylique
Dossier:
densité 21 kg x m³ + couche acrylique

SUSPENSION D'ASSISE

Sangles élastiques haute résistance

REVELEMENT

Tissu:
totalement déhoussable
PVC:
partiellement déhoussable

Disponible avec matelas H. 18 cm

VOGUE fisso . fixed . fixe

STRUTTURA

Struttura in multistrato di legno e altri derivati del legno

IMBOTTITURA

Poliuretano espanso a densità differenziate e falda di ovatta acrilica
Seduta:
densità 35 kg x m³
Spalliera:
densità 21 kg x m³

SOSPENSIONE SEDUTA

Cinghie elastiche ad alta resistenza

RIVESTIMENTO

Tessuto:
completamente sfoderabile
Ecopelle:
parzialmente sfoderabile

STRUCTURE

Framework in poplar, fir and various derivatives

UPHOLSTERY

Polyurethane foam-various densities + acrylic wadding
Seats:
density 35 kg x m³
Backrest:
density 21 kg x m³

SEAT SUPPORT

High strength elastic straps

COVERING

Fabric:
fully removable
Artificial leather:
partially removable

STRUCTURE

Sapin peuplier, multiplis et panneaux de particules

GARNISSAGE

Mousse polyuréthane expansé haute résilience
Assises:
densité 35 kg x m³ + couche acrylique
Dossier:
densité 21 kg x m³ + couche acrylique

SUSPENSION D'ASSISE

Sangles élastiques haute résistance

REVELEMENT

Tissu:
totalement déhoussable
PVC:
partiellement déhoussable

poltrona . divano / armchair . sofa / fauteuil . canapé

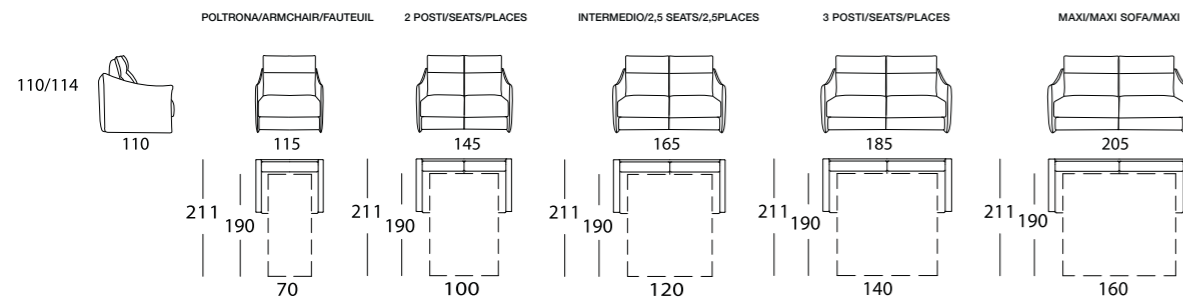

poltrona . divano / armchair . sofa / fauteuil . canapé

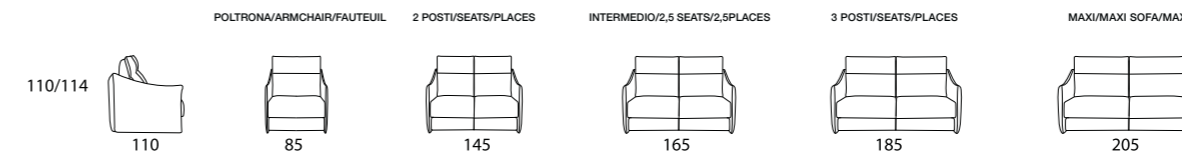

chaise longue contenitore sx-dx / longue chair container left-right / chaise longue coffre gauche-droite

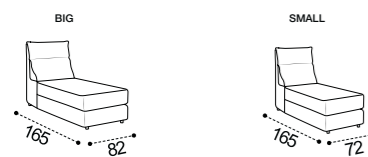

chaise longue contenitore sx-dx / longue chair container left-right / chaise longue coffre gauche-droite

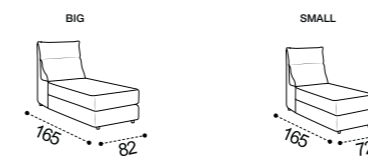

apertura divano / opening sofa / ouverture du canapé

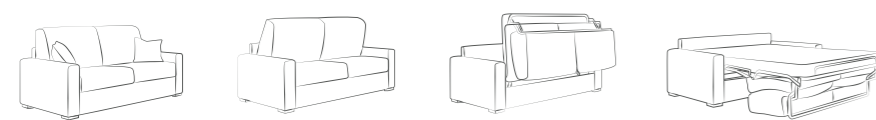

pouff / ottoman / pouf

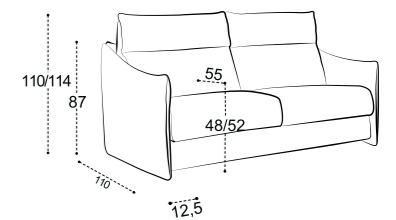
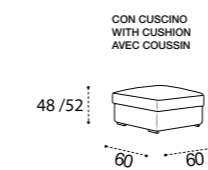

composizione C1 / composition C1 / composition C1

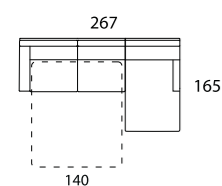

divano 3PS letto+chaise longue big
3PLCS sofa bed+loungue chair big
canapé 3PL lit+chaise longue big

specificare lato chaise longue destra o sinistra
to specify right or left chaise-longue
spécifier si chaise-longue droite ou gauche

composizione C1 / composition C1 / composition C1

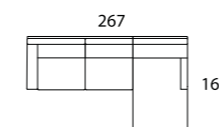

divano 3PS fisso+chaise longue big
3PLCS sofa+loungue chair big
canapé 3PL fixe+chaise longue big

specificare lato chaise longue destra o sinistra
to specify right or left chaise-longue
spécifier si chaise-longue droite ou gauche

TIMES

Un look frizzante, morbido e accattivante, che grazie ai profili realizzabili con colori a contrasto permette di sviluppare innumerevoli soluzioni ricche e personalissime. Disponibile nella versione fisso e letto con materasso h. 14 e 18 cm.

A sparkling look, soft and attractive that, thanks to the contrast colour and profiles, allows you to develop many interesting and individual solutions. Available in fixed and bed version with 14cm or 18cm deep mattresses.

Un look pétillant, souple et séduisant ; ses finitions permettent de personnaliser ce canapé avec des contrastes plus ou moins forts. Disponible en version fixe et convertible avec matelas de 14 et 18cm.





COMPOSIZIONE C1 . L. 267 x P. 165 H. 110/114 cm _ BEAUTY POLTRONA . L. 80 P. 80 H. 84 cm



DIVANO 3 POSTI . L. 185 P. 110 H. 110/114 cm _ BEAUTY POLTRONA . L. 80 P. 80 H. 84 cm

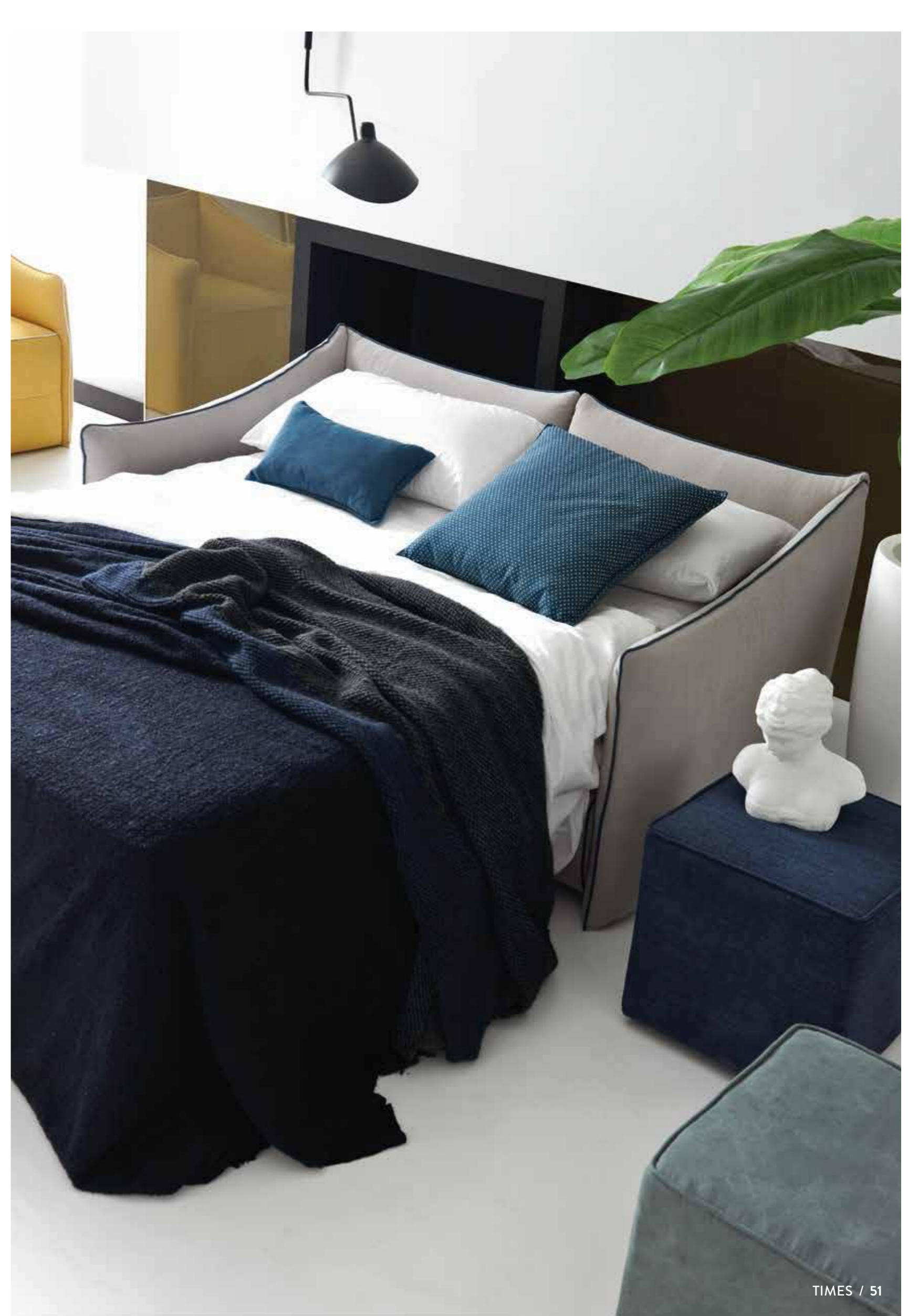

TIMES letto . bed . lit

Divano letto trasformabile con rete elettrosaldata

MATERASSO DI SERIE
LUXURY H. 14 cm

MECCANISMO
Rete SPIDER

STRUTTURA

Metallica con parti esterne in pannelli di agglomerato di legno applicati con innesto a baionetta

IMBOTTITURA

Poliuretano espanso a densità differenziate e falda di ovatta acrilica
Seduta:
densità 35 kg x m³
Spalliera:
densità 21 kg x m³

SOSPENSIONE SEDUTA

Cinghie elastiche ad alta resistenza

RIVESTIMENTO

Tessuto:
completamente sfoderabile
Ecopelle:
parzialmente sfoderabile

Disponibile anche con materasso H. 18 cm

Sofa bed with metal rigid electrowelded grid

MATTRESS STANDARD
LUXURY H. 14 cm

MECHANISM
SPIDER grid

STRUCTURE

Strong metallic structure, wooden particle boards with bayonet-joint

UPHOLSTERY

Polyurethane foam-various densities + acrylic wadding
Seats:
density 35 kg x m³
Backrest:
density 21 kg x m³

SEAT SUPPORT

High strength elastic straps

COVERING

Fabric:
fully removable
Artificial leather:
partially removable

Also available with mattress H. 18 cm

Canapé lit transformable avec sommier e'lectrosoude'

MATELAS STANDARD
LUXURY H. 14 cm

MÉCANISME
Sommier SPIDER

STRUCTURE

Carcasse métallique, accoudoirs et bandeaux en contreplaqué, démontés à appliquer avec enclenchement à baionnette

GARNISSAGE

Mousse polyuréthane expansé haute résilience
Assises:
densité 35 kg x m³ + couche acrylique
Dossier:
densité 21 kg x m³ + couche acrylique

SUSPENSION D'ASSISE

Sangles élastiques haute résistance

REVEITEMENT

Tissu:
totalement déhoussable
PVC:
partiellement déhoussable

Disponible avec matelas H. 18 cm

TIMES fisso . fixed . fixe

STRUTTURA

Struttura in multistrato di legno e altri derivati del legno

IMBOTTITURA

Poliuretano espanso a densità differenziate e falda di ovatta acrilica
Seduta:
densità 35 kg x m³
Spalliera:
densità 21 kg x m³

SOSPENSIONE SEDUTA

Cinghie elastiche ad alta resistenza

RIVESTIMENTO

Tessuto:
completamente sfoderabile
Ecopelle:
parzialmente sfoderabile

STRUCTURE

Framework in poplar, fir and various derivatives

UPHOLSTERY

Polyurethane foam-various densities + acrylic wadding
Seats:
density 35 kg x m³
Backrest:
density 21 kg x m³

SEAT SUPPORT

High strength elastic straps

COVERING

Fabric:
fully removable
Artificial leather:
partially removable

STRUCTURE

Sapin peuplier, multiplis et panneaux de particules

GARNISSAGE

Mousse polyuréthane expansé haute résilience
Assises:
densité 35 kg x m³ + couche acrylique
Dossier:
densité 21 kg x m³ + couche acrylique

SUSPENSION D'ASSISE

Sangles élastiques haute résistance

REVEITEMENT

Tissu:
totalement déhoussable
PVC:
partiellement déhoussable

poltrona . divano / armchair . sofa / fauteuil . canapé

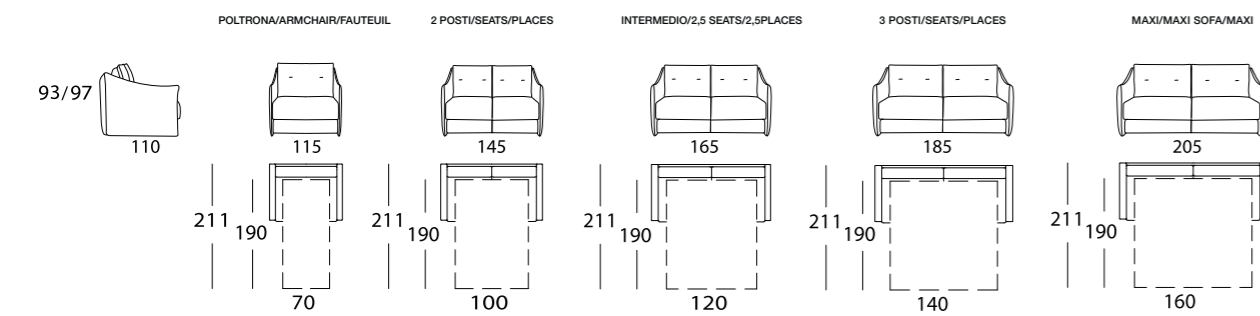

poltrona . divano / armchair . sofa / fauteuil . canapé

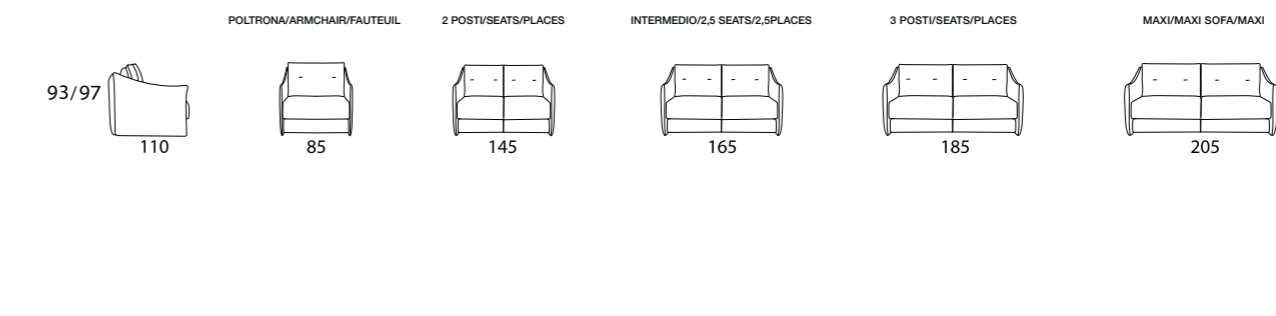

chaise longue contenitore sx-dx / lounge chair container left-right / chaise longue coffre gauche-droite

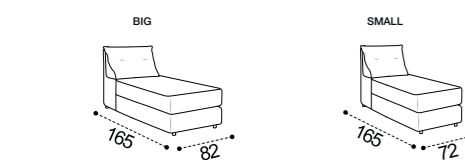

chaise longue contenitore sx-dx / lounge chair container left-right / chaise longue coffre gauche-droite

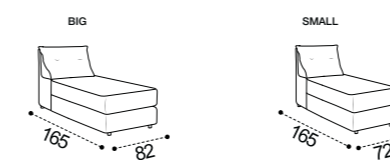

apertura divano / opening sofa / ouverture du canapé

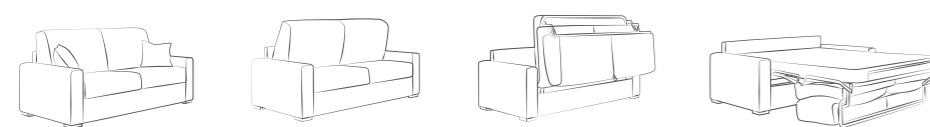

pouff / ottoman / pouf

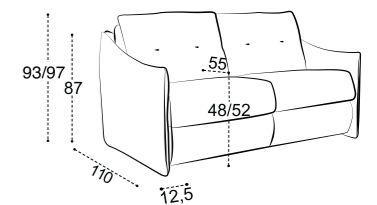
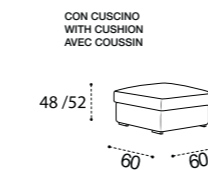

composizione C1 / composition C1 / composition C1

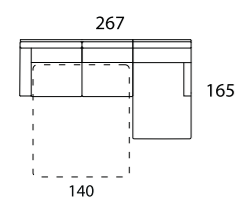

divano 3PS letto+chaise longue big
3PLCS sofa bed+lounge chair big
canapé 3PL lit+chaise-longue big

specificare lato chaise longue destra o sinistra
to specify right or left chaise-longue
spécifier si chaise-longue droite ou gauche

composizione C1 / composition C1 / composition C1

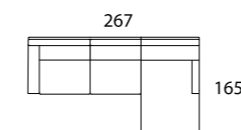

divano 3PS fisso+chaise longue big
3Plcs sofa+lounge chair big
canapé 3PL fixe+chaise-longue big

specificare lato chaise longue destra o sinistra
to specify right or left chaise-longue
spécifier si chaise-longue droite ou gauche

KIMI

Linee essenziali e volumi confortevoli, i poggiatesta reclinabili rafforzano il profilo dello schienale offrendo momenti di grande comfort. Le sedute sono sollevate da terra da piedini metallici che creano uno stacco visivo dal pavimento. Disponibile nella versione fisso, letto e con relax elettrico.

Essential, comfortable lines that speak volumes. The reclining headrest add to the back's profile offering moments of great comfort, together with youthful look with high seats. Also available in bed or fixed version with a motorised recliner.

Une ligne généreuse et un look très jeune. Des têtes réglables renforcent le profil du dossier qui offre un grand confort, assises et pieds hauts. Disponible en fixe, en convertible et relax électrique.







A CIASCUNO IL SUO COMFORT



IL DESIGN
NON È MAI,
STATO COSÌ
COMODO





DIVANO 3 POSTI . L. 208 P. 100 H. 96/112 cm



KIMI letto . bed . lit

Divano letto trasformabile con rete elettrosaldata

MATERASSO DI SERIE LUXURY H. 12 cm

STRUTTURA

Struttura in multistrato di legno e altri derivati del legno

IMBOTTITURA

Poliuretano espanso a densità differenziate e falda di ovatta acrilica

Seduta: densità 32 kg x m³
Spalliera: densità 21 kg x m³

SOSPENSIONE SEDUTA

Cinghie elastiche ad alta resistenza

RIVESTIMENTO

Tessuto: completamente sfoderabile
Ecopelle: parzialmente sfoderabile

OPTIONAL

- piedino CIMABUE H. 12 cm

Sofa bed with metal rigid electrowelded grid

MATTRESS STANDARD LUXURY H. 12 cm

STRUCTURE

Framework in poplar, fir and various derivatives

UPHOLSTERY

Polyurethane foam - various densities + acrylic wadding

Seats: density 32 kg x m³
Backrest: density 21 kg x m³

SEAT SUPPORT

High strength elastic straps

COVERING

Fabric: fully removable
Artificial leather: partially removable

OPTIONAL EXTRA

- feet CIMABUE H. 12 cm

Canapé lit transformable avec sommier électrosoudé

MATELAS STANDARD LUXURY H. 12 cm

STRUCTURE

Sapin peuplier, multiplis et panneaux de particules

GARNISSAGE

Mousse polyuréthane expansé haute résilience

Assises: densité 32 kg x m³ + couche acrylique
Dossier: densité 21 kg x m³ + couche acrylique

SUSPENSION D'ASSISE

Sangles élastiques haute résistance

REVEITEMENT

Tissu: totalement déhoussable
PVC: partiellement déhoussable

OPTION

- pied CIMABUE H. 12 cm

KIMI fisso/relax . fixed/relax . fixe/relax

STRUTTURA

Struttura in multistrato di legno e altri derivati del legno

IMBOTTITURA

Poliuretano espanso a densità differenziate e falda di ovatta acrilica

Seduta: densità 32 kg x m³
Spalliera: densità 21 kg x m³

SOSPENSIONE SEDUTA

Cinghie elastiche ad alta resistenza

RIVESTIMENTO

Tessuto: completamente sfoderabile
Ecopelle: parzialmente sfoderabile

OPTIONAL

- relax elettrico
- piedino CIMABUE H. 12 cm
- batteria ricaricabile

STRUCTURE

Framework in poplar, fir and various derivatives

UPHOLSTERY

Polyurethane foam - various densities + acrylic wadding

Seats: density 32 kg x m³
Backrest: density 21 kg x m³

SEAT SUPPORT

High strength elastic straps

COVERING

Fabric: fully removable
Artificial leather: partially removable

OPTIONAL EXTRA

- motorised recliner
- feet CIMABUE H. 12 cm
- rechargeable battery

STRUCTURE

Sapin peuplier, multiplis et panneaux de particules

GARNISSAGE

Mousse polyuréthane expansé haute résilience

Assises: densité 32 kg x m³ + couche acrylique
Dossier: densité 21 kg x m³ + couche acrylique

SUSPENSION D'ASSISE

Sangles élastiques haute résistance

REVEITEMENT

Tissu: totalement déhoussable
PVC: partiellement déhoussable

OPTIONS

- relax électrique
- pied CIMABUE H. 12 cm
- batterie pour relax électrique

poltrona . divano / armchair . sofa / fauteuil . canapé

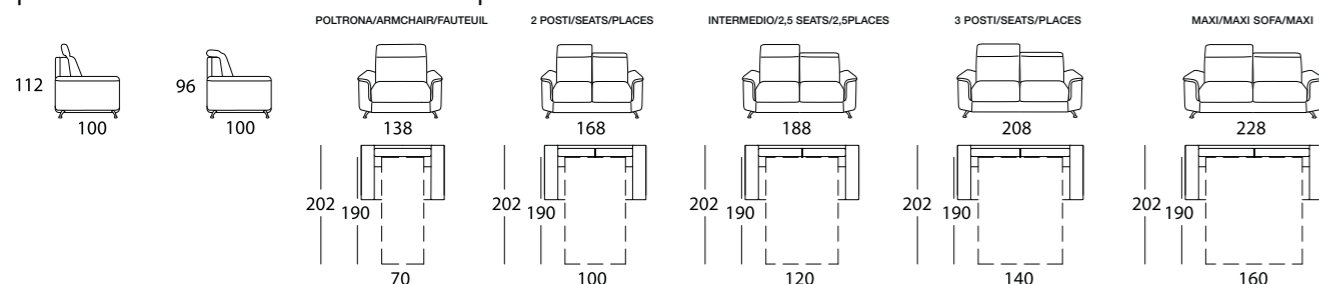

poltrona . divano / armchair . sofa / fauteuil . canapé

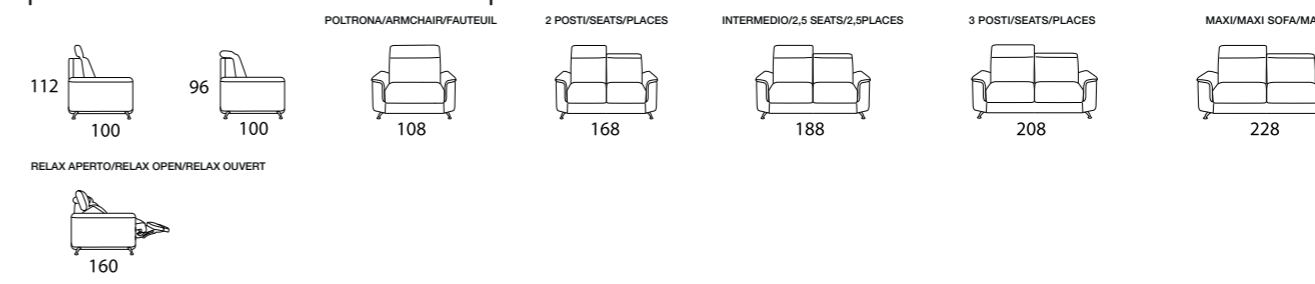

laterale sx-dx / element left-right / élément gauche-droite

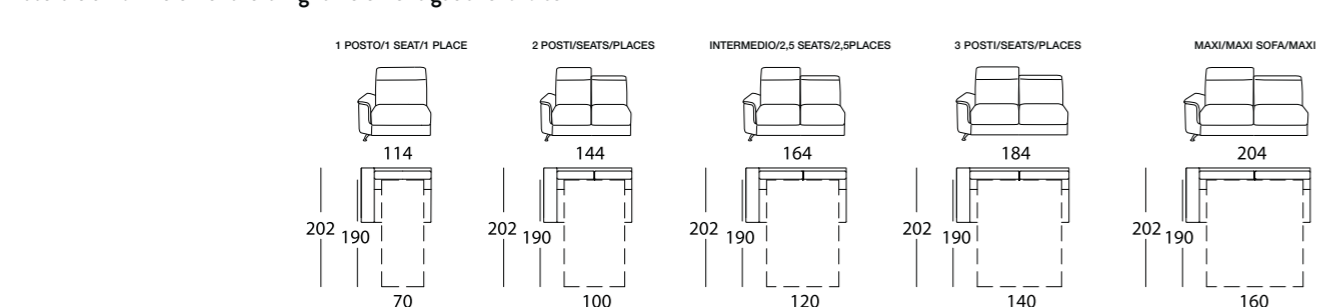

laterale sx-dx / element left-right / élément gauche-droite

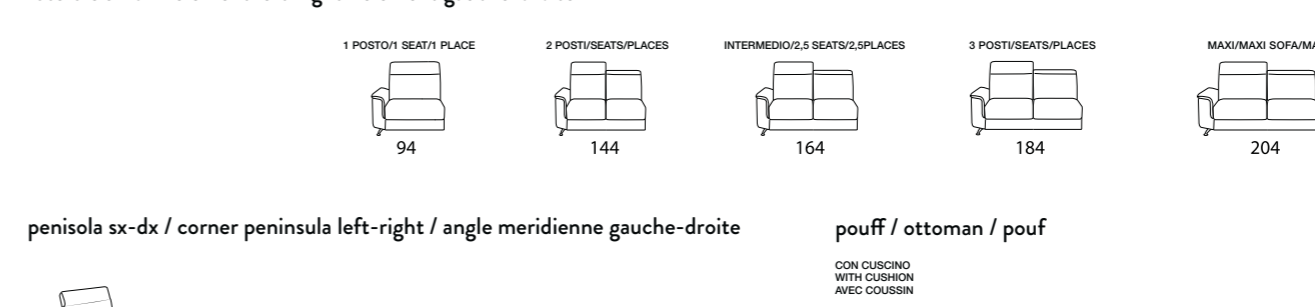

penisola sx-dx / corner peninsula left-right / angle meridienne gauche-droite

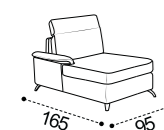

apertura divano / opening sofa / ouverture du canapé

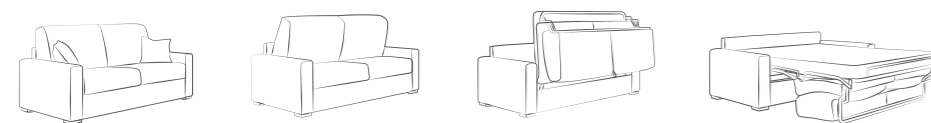

penisola sx-dx / corner peninsula left-right / angle meridienne gauche-droite

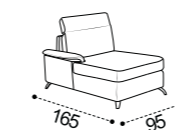

pouff / ottoman / pouf

CON CUSCINO
WITH CUSHION
AVEC COUSSIN

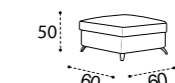

optional / optional extra / options



CIMABUE piedino H. 12 cm
CIMABUE feet H. 12 cm
CIMABUE pied H. 12 cm

Per la versione letto e relax con piedino in metallo optional saranno presenti i piedini di sostegno della rete.

For bed and electric recliner versions with optional steel feet there will be additional feet to support the structure."

Ce modèle avec pieds métalliques en option aura de pieds de soutien sous la structure, soit en versions convertible et relax .

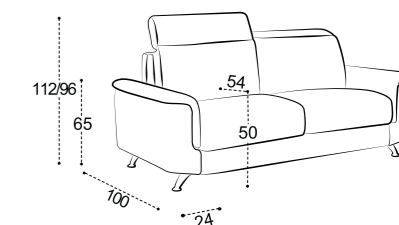

composizione C1 / composition C1 / composition C1

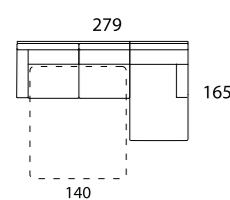

laterale 3PS letto+penisola
3PLCS side sofa bed+peninsula
terminal 3PL lit+angle meridienne

specificare lato penisola destra o sinistra
to specify right or left peninsula
spécifier si chaise-longue droite ou gauche

composizione C1 / composition C1 / composition C1

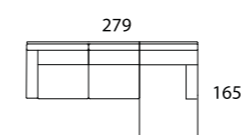

laterale 3PS fisso+penisola
3PLCS side sofa bed+peninsula
terminal 3PL fixe+angle meridienne

specificare lato penisola destra o sinistra
to specify right or left peninsula
spécifier si chaise-longue droite ou gauche

CHLOE'

Bello e possibile. Un'idea estremamente nuova, versatile ed accattivante. Molto più di un semplice divano, Chloe' unisce tutto in uno le comodità di un divano angolare, quelle di un divano con doppia penisola ma anche quelle di un letto che può essere matrimoniale oppure a doppio letto singolo.

This is a new, beautiful, versatile, affordable and captivating idea. Much more than "just a sofa", Chloe' has the comfort of a corner sofa, those of a couch with individual lounge chairs, but also those of a bed that can be queen or twin singles.

Le canapé, Chloe', une idée neuve, modulable il réunit le confort d'un canapé d'angle, un canapé avec double chaise-longue, et aussi un convertible qui peut être à deux places ou avec deux lits séparés.





COMPOSIZIONE ANGOLARE . L. 278 x 207 P. 94 H. 97 cm + POUFF . L. 76 P. 77 H. 46 cm

VERSATILITÀ E COMODITÀ IN UN COLPO SOLO



COMPOSIZIONE VERSIONE LETTO MATRIMONIALE . L. 246 x 190 P. 94 H. 97 cm



COMPOSIZIONE VERSIONE LETTI SINGOLI . L. 246 x 190 P. 94 H. 97 cm

CHLOE'

STRUTTURA

Struttura in multistrato di legno e altri derivati del legno

IMBOTTITURA

Poliuretano espanso a densità differenziate e falda di ovatta acrilica
 Seduta:
 densità 35 kg x m³
 Spalliera:
 densità 21 kg x m³

SOSPENSIONE SEDUTA

Pannello in multistrato rigido ad alta resistenza

RIVESTIMENTO

Tessuto:
 completamente sfoderabile
 Ecopelle:
 parzialmente sfoderabile

OPTIONAL

- poggiatesta

STRUCTURE

Framework in poplar, fir and various derivatives

UPHOLSTERY

Polyurethane foam - various densities + acrylic wadding
 Seats:
 density 35 kg x m³
 Backrest:
 density 21 kg x m³

SEAT SUPPORT

Rigid strong panel

COVERING

Fabric:
 fully removable
 Artificial leather:
 partially removable

OPTIONAL EXTRA

- headrest

STRUCTURE

Sapin peuplier, multiplis et panneaux de particules

GARNISSAGE

Mousse polyuréthane expansé haute résilience
 Assises:
 densité 35 kg x m³ + couche acrylique
 Dossier:
 densité 21 kg x m³ + couche acrylique

SUSPENSION D'ASSISE

Panneau rigide, grande résistance

RETEMENT

Tissu:
 totalement déhoussable
 PVC:
 partiellement déhoussable

OPTION

- appui-tête



divano / sofa / canapé

COMPOSIZIONE ANGOLARE/CORNER COMPOSITION/COMPOSITION ANGLE

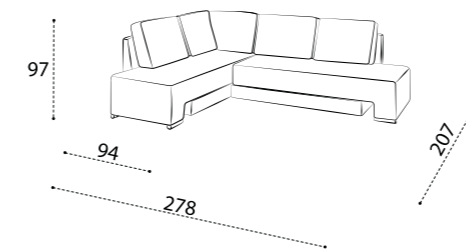
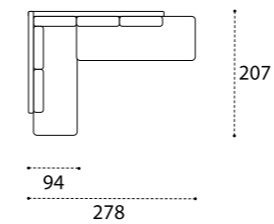

VERSIONE LETTO MATRIMONIALE/DOUBLE BED VERSION/VERSION LIT A DEUX PLACES

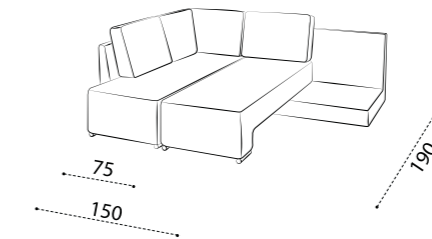
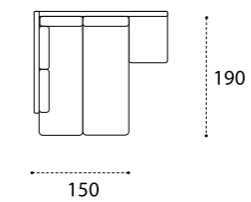

VERSIONE LETTI SINGOLI/TWIN SINGLE OPTION/VERSION AVEC DEUX LITS SEPARÉS

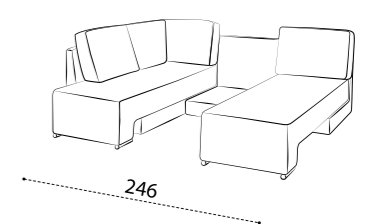
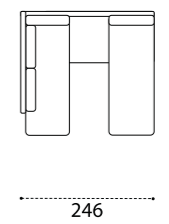

specificare lato penisola destra o sinistra
 to specify right or left peninsula
 spécifier si angle méridienne gauche-droite

pouff / ottoman / pouf

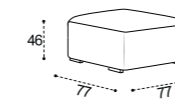

optional / optional extra / option

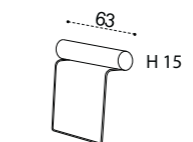

poggiatesta
 headrest
 appui-tête

KALIKA

Ricco nel design ma anche nelle funzioni che grazie alle sedute scorrevoli permettono più soluzioni di comfort. Tutt'altro che banale, un divano importante da veri intenditori.

Full of design and functions that, thanks to the sliding seats, allow more comfortable solutions. Anything but dull, a very discerning couch.

Un design riche. Un modèle avec des assises glissantes ou l'on réunit l'élégance, la fonctionnalité et le confort.





COMPOSIZIONE C1. L. 300 x P. 210 H. 90 cm

KALIKA / 111



SE IL VOSTRO PROBLEMA È IL RELAX, QUESTA È LA SOLUZIONE







DIVANO 3 POSTI . L. 218 P. 105/142 H. 90 cm





KALIKA scorrevole . sliding . glissante

STRUTTURA

Struttura in multistrato di legno e altri derivati del legno

IMBOTTITURA

Seduta:
densità 32 kg x m³
Spalliera:
poliuretano espanso densità 21 kg x m³ +
ovatta acrilica

SOSPENSIONE SEDUTA

Cinghie elastiche ad alta resistenza

RIVESTIMENTO

Tessuto:
completamente sfoderabile
Ecopelle:
parzialmente sfoderabile

PIEDINI

in metallo - colore acciaio

OPTIONAL

- piedini in legno-colore wengé
- schienale con rullo

STRUCTURE

Framework in poplar, fir and various derivatives

UPHOLSTERY

Seats:
density 32 kg x m³
Backrest:
polyurethane foam - density 21 kg x m³ +
acrylic wadding

SEAT SUPPORT

High strength elastic straps

COVERING

Fabric:
fully removable
Artificial leather:
partially removable

FEET

in metal - steel colour

OPTIONAL EXTRA

- wood feet-wengé colour
- backrest with roll cushion

STRUCTURE

Sapin peuplier, multiplis et panneaux de particules

GARNISSAGE

Assises:
densité 32 kg x m³
Dossier:
polyuréthane expansé densité 21 kg x m³ +
couche acrylique

SUSPENSION D'ASSISE

Sangles élastiques haute résistance

REVETEMENT

Tissu:
totalemet déhoussable
PVC:
partiellement déhoussable

PIEDS

en métal - couleur acier

OPTIONS

- pieds en bois-colour wengé
- dossier avec "boudin"

divano . pouff / sofa . ottoman / canapé . pouf

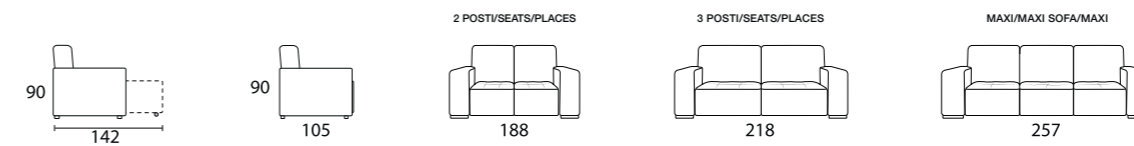

laterale sx-dx / element left-right / élément gauche-droite

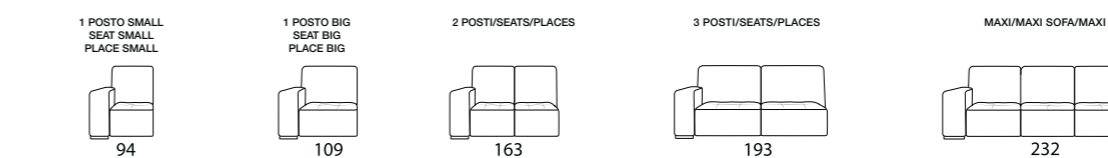

chaise longue sx-dx / chaise longue left-right / chaise longue gauche-droite

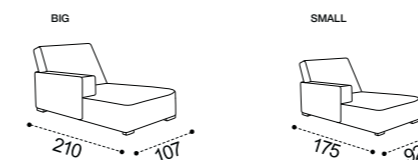

pouff / ottoman / pouf

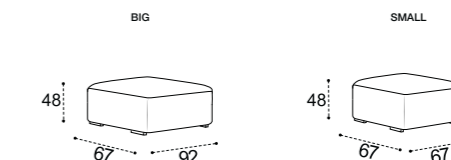

optional / optional extra / options



piedini in legno - colore wengé
wood feet - wengé colour
pieds en bois - couleur wengé

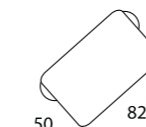

cuscinò KALIKA con rullo
scatter KALIKA with roll
coussin KALIKA avec rouleau

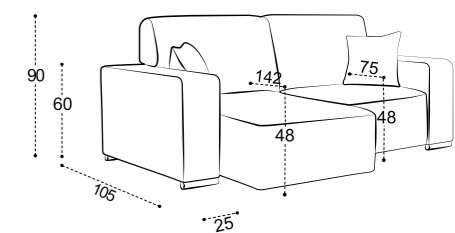

composizione C1 / composition C1 / composition C1

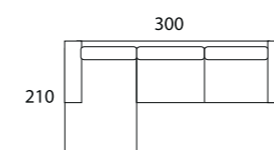

laterale 3PS scorrevole+chaise longue big
3PLCS side sofa sliding+longue chair big
terminal 3PL glissant+chaise longue big

composizione C2 / composition C2 / composition C2

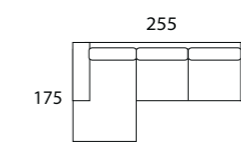

laterale 2PS scorrevole+chaise longue small
2PLCS side sofa sliding+chaise longue small
terminal 2PL glissant+chaise longue small

specificare lato chaise longue destra o sinistra
to specify right or left chaise-longue
spécifier si angle méridienne droite ou gauche

EGO

Un design tradizionale dalle forme ampie e morbide. I cuscini sui braccioli che si appoggiano dolcemente sulle sedute lo rendono particolarmente accogliente. La sua ampia componibilità gli consente di sviluppare molte versioni per adattarsi meglio a tutte le situazioni. Disponibile nella versione fisso e letto.

A traditional design with large, soft shapes. The soft, shaped pillows on the arms make it particularly comfortable. Its wide modular system allows you to develop its many options into any solution. Available in fixed and bed version.

Un design traditionnel avec des lignes harmonieuses et souples. Les coussins des accoudoirs s'appuient doucement sur les assises, un canapé modulable, en version fixe et convertible.



I POSTI
MIGLIORI
DA CUI
GODERSI IL
MASSIMO
DEL RELAX





COMPOSIZIONE A . L. 305 x P. 178 H. 98 cm

EGO / 133



DIVANO 3 POSTI . L. 216 P. 98 H. 98 cm



EGO letto . bed . lit

Divano letto trasformabile con rete elettrosaldata

MATERASSO DI SERIE
LUXURY H. 12 cm

STRUTTURA

Struttura in multistrato di legno e altri derivati del legno

IMBOTTITURA

Poliuretano espanso a densità differenziate e falda di ovatta acrilica
Seduta:
densità 32 kg x m³
Spalliera:
densità 21 kg x m³

RIVESTIMENTO

Tessuto:
completamente sfoderabile
Ecopelle:
parzialmente sfoderabile

Sofa bed with metal rigid electrowelded grid

MATTRESS STANDARD
LUXURY H. 12 cm

STRUCTURE

Framework in poplar, fir and various derivatives

UPHOLSTERY

Polyurethane foam - various densities + acrylic wadding
Seats:
density 32 kg x m³
Backrest:
density 21 kg x m³

COVERING

Fabric:
fully removable
Artificial leather:
partially removable

Canapé lit transformable avec sommier électrosoudé

MATELAS STANDARD
LUXURY H. 12 cm

STRUCTURE

Sapin peuplier, multiplis et panneaux de particules

GARNISSAGE

Mousse polyuréthane expansé haute résilience
Assises:
densité 32 kg x m³ + couche acrylique
Dossier:
densité 21 kg x m³ + couche acrylique

REVELEMENT

Tissu:
totalement déhoussable
PVC:
partiellement déhoussable

EGO fisso . fixed . fixe

STRUTTURA

Struttura in multistrato di legno e altri derivati del legno

IMBOTTITURA

Poliuretano espanso a densità differenziate e falda di ovatta acrilica
Seduta:
densità 32 kg x m³
Spalliera:
densità 21 kg x m³

SOSPENSIONE SEDUTA

Cinghie elastiche ad alta resistenza

RIVESTIMENTO

Tessuto:
completamente sfoderabile
Ecopelle:
parzialmente sfoderabile

OPTIONAL

- cuscini

STRUCTURE

Framework in poplar, fir and various derivatives

UPHOLSTERY

Polyurethane foam - various densities + acrylic wadding
Seats:
density 32 kg x m³
Backrest:
density 21 kg x m³

SEAT SUPPORT

High strength elastic straps

COVERING

Fabric:
fully removable
Artificial leather:
partially removable

OPTIONAL EXTRA

- cushion

STRUCTURE

Sapin peuplier, multiplis et panneaux de particules

GARNISSAGE

Mousse polyuréthane expansé haute résilience
Assises:
densité 32 kg x m³ + couche acrylique
Dossier:
densité 21 kg x m³ + couche acrylique

SUSPENSION D'ASSISE

Sangles élastiques haute résistance

REVELEMENT

Tissu:
totalement déhoussable
PVC:
partiellement déhoussable

OPTIONS

- coussin

poltrona . divano / armchair . sofa / fauteuil . canapé

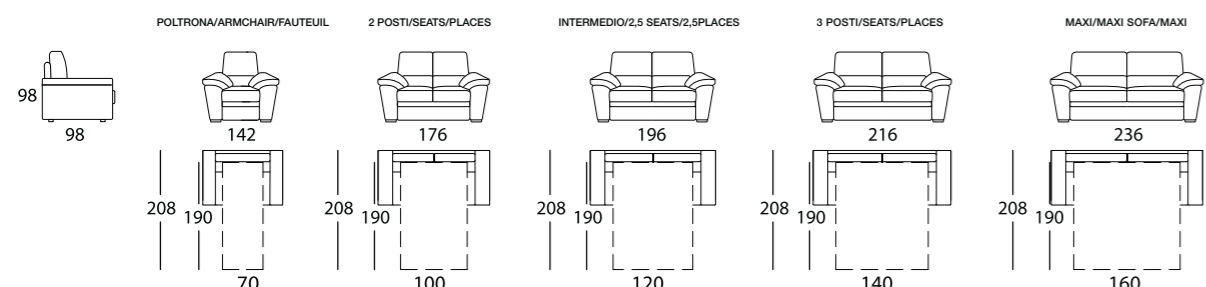

laterale sx-dx / element left-right / élément gauche-droite

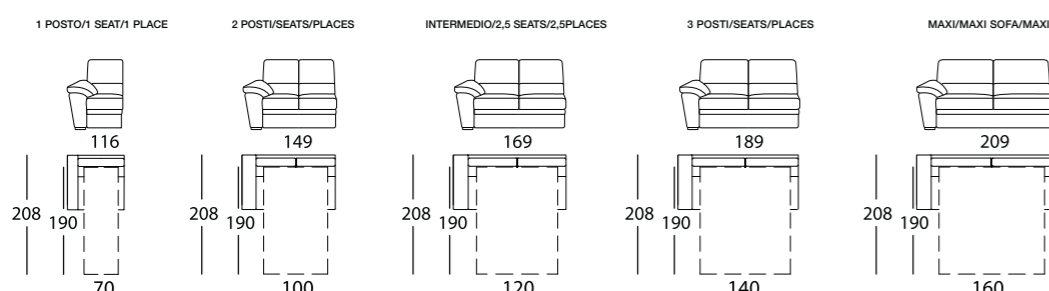

apertura divano / opening sofa / ouverture du canapé

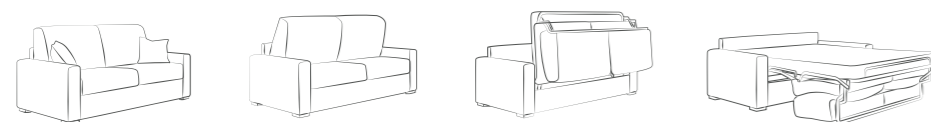

poltrona . divano / armchair . sofa / fauteuil . canapé

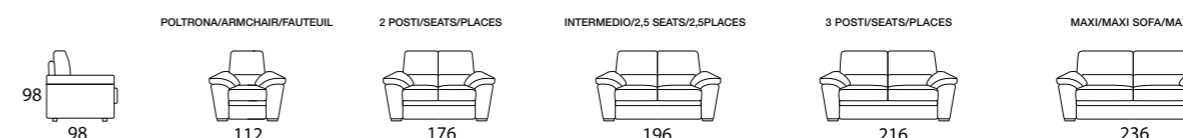

laterale sx-dx / element left-right / élément gauche-droite

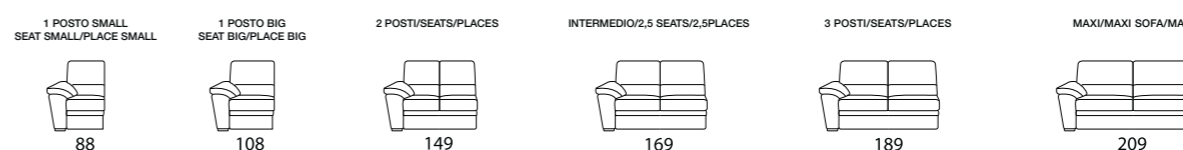

chaise longue sx-dx fissa chaise longue left-right fixed chaise longue fixe gauche-droite

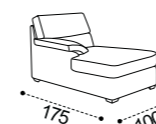

chaise longue sx-dx contenitore storage chaise longue left-right chaise longue coffre gauche-droite

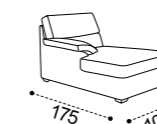

specificare lato chaise longue destra o sinistra
to specify right or left chaise-longue
spécifier si chaise-longue droite ou gauche

angolo . pouff / corner . ottoman / angle . pouf

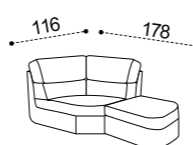

angolo / corner / angle

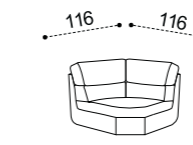

optional / optional extra / options



cuscin / cushion / coussin
cm. 65x65



cuscin / cushion / coussin
cm. 65x65



cuscin / cushion / coussin
cm. 65x65

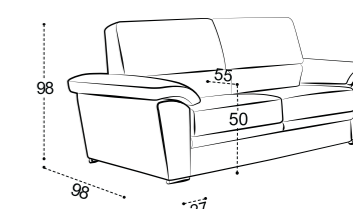

composizione C1 sx-dx / composition C1 left-right / composition C1 gauche-droite

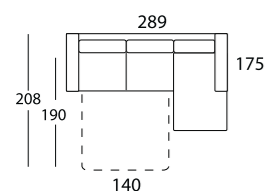

laterale 3PS letto+chaise longue fissa
3 PLCS side sofa bed+lounge chair
terminal 3PL lit+chaise longue fixe

composizione A sx-dx / composition A left-right / composition A gauche-droite

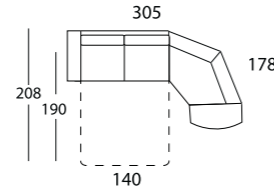

laterale 3PS letto+angolo con pouff
3PLCS side sofa + corner ottoman
terminal 3PL lit+angle pouf

specificare lato penisola destra o sinistra
to specify right or left peninsula
spécifier si angle méridienne droite ou gauche

composizione C1 sx-dx / composition C1 left-right / composition C1 gauche-droite

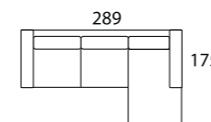

laterale 3PS fisso+chaise longue fissa
3PLCS side sofa+lounge chair
terminal 3PL fixe+chaise longue fixe

composizione A sx-dx / composition A left-right / composition A gauche-droite

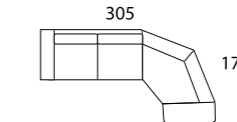

laterale 3PS fisso+angolo con pouff
3PLCS side sofa+lounge chair
terminal 3PL fixe+angle pouf

specificare lato penisola destra o sinistra
to specify right or left peninsula
spécifier si angle méridienne droite ou gauche

DONATELLO

Una linea classica ma anche moderna a seconda di come lo vestiamo, che racchiude in se una concezione di comodità e volumi ben interpretati da forme e riferimenti che richiamano al passato ma si adattano bene anche al vivere contemporaneo.

A classic line that becomes modern according to the "dress" chosen. It contains a concept of comfort and seating which recall past shapes that fit well into contemporary living.

Un modèle classique : un confort généreux et des volumes bien proportionnés qui s'adaptent au présent.





COMPOSIZIONE T1 . L. 277 x P. 200 H. 94 cm

DONATELLO / 141



DIVANO 3 POSTI . L. 208 P. 87 H. 94 cm



DIVANO 3 POSTI . L. 208 P. 87 H. 94 cm _ DONATELLO POLTRONA . L. 102 P. 87 H. 94 cm

DONATELLO / 145

DONATELLO fisso/letto . fixed/bed . fixe/lit

STRUTTURA

Struttura in multistrato di legno e altri derivati del legno

STRUCTURE

Framework in poplar, fir and various derivatives

STRUCTURE:

Sapin peuplier, multiplis et panneaux de particules

IMBOTTITURA

Poliuretano espanso a densità differenziate e falda di ovatta acrilica
Seduta:
molle insacchettate + gomma densità 30 kg x m³
Spalliera:
densità 21 kg x m³

UPHOLSTERY

Polyurethane foam-various densities + acrylic wadding
Seats:
pocket springs + foam 30 kg x m³
Backrest:
density 21 kg x m³

GARNISSAGE

Mousse polyuréthane expansé haute résilience
Assises:
ressorts ensachés + couche densité 30 kg x m³
Dossier:
densité 21 kg x m³ + couche acrylique

SOSPENSIONE SEDUTA

Cinghie elastiche ad alta resistenza

SEAT SUPPORT

High strength elastic straps

SUSPENSION D'ASSISE

Sangles élastiques haute résistance

RIVESTIMENTO

Tessuto:
completamente sfoderabile
Ecopelle:
non sfoderabile

COVERING

Fabric:
fully removable
Artificial leather:
not removable

RETEMENT

Tissu:
totalement déhoussable
PVC:
non déhoussable

OPTIONAL

- cuscino schienale banquette
- bordino su braccioli e cuscini arredo
- letto "DUO" materasso H 12 cm
- poggiatesta

OPTIONAL EXTRA

- cushion for banquette
- piping on arms and scatter cushions
- "DUO" bed mattress H 12 cm
- headrest

OPTIONS

- coussin dossier banquette
- passepoil sur accoudoirs et coussins déco
- lit "DUO" matelas H 12 cm
- appui-tête

poltrona . divano / armchair . sofa / fauteuil . canapé

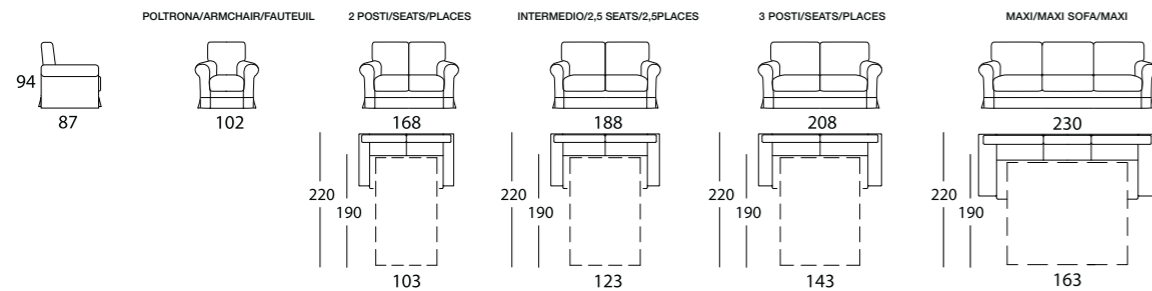

laterale sx-dx / element left-right / élément gauche-droite



angolo terminale sx-dx corner terminal left-right angle terminal gauche-droite

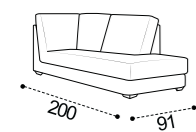

chaise longue sx-dx chaise longue left-right chaise longue gauche-droite

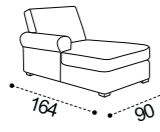

banquette

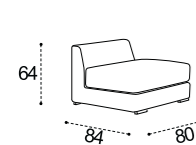

angolo corner angle

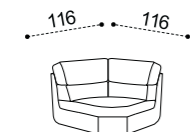

pouff / ottoman / pouf

POUFF SENZA CUSCINO
OTTOMAN WITHOUT CUSHION
POUF SANS COUSSIN

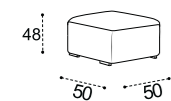

POUFF BIG CON CUSCINO
OTTOMAN BIG WITH CUSHION
POUF BIG AVEC COUSSIN

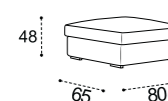

POUFF SMALL CON CUSCINO
OTTOMAN SMALL WITH CUSHION
POUF SMALL AVEC COUSSIN

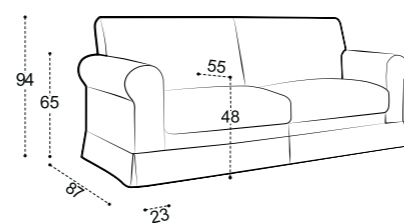
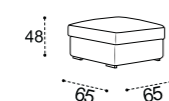

optional / optional extra / options



bordino a contrasto
contrasting color piping
passepoil contrasté

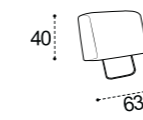

cuscino schienale banquette
back-cushion for banquette
coussin dossier banquette

di serie / standard / standard



molle insacchettate
pocket springs
ressorts ensachés



letto "DUO" materasso cm. 12 H
"DUO" bed mattress cm. 12 H
lit "DUO" matelas cm. 12 H

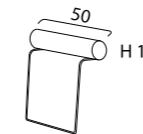

poggiatesta
headrest
appui-tête

composizione A1 sx-dx / composition A1 left-right / composition A1 gauche-droite

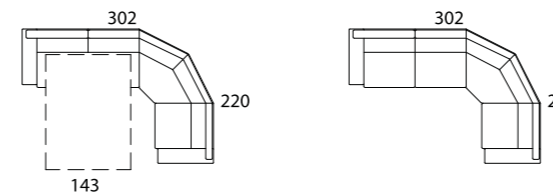

laterale 3PS letto+angolo+laterale 1 PS A
3PLCS side sofa+corner+side 1 PS A
terminal 3PL+angle+terminal 1 PS A

composizione B1 sx-dx / composition B1 left-right / composition B1 gauche-droite

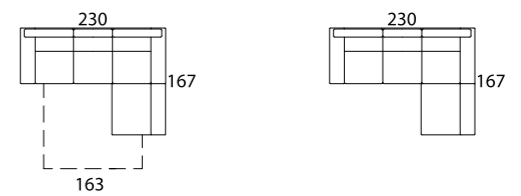

divano maxi+banquette
maxi sofa+banquette
canapé maxi+banquette

composizione C1 sx-dx / composition C1 left-right / composition C1 gauche-droite

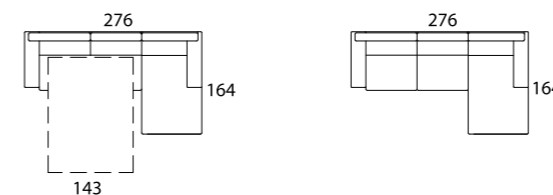

laterale 3PS letto+chaise longue
3PLCS side sofa+lounge chair
terminal 3PL+chaise longue

composizione T1 sx-dx / composition T1 left-right / composition T1 gauche-droite

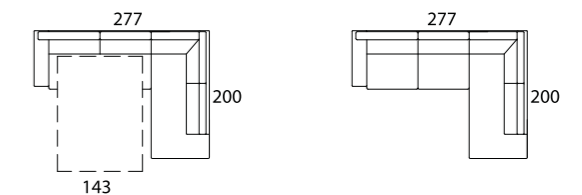

laterale 3PS+angolo terminale
3PLCS side sofa+corner terminal
terminal 3PL+angle terminal

specificare lato penisola destra o sinistra
to specify right or left peninsula
spécifier si angle méridienne droite ou gauche

CIMABUE

Linee pulite e leggere gli donano un fascino molto accattivante e sbarazzino. Contemporaneo, fresco e non banale.

Clean, light lines give an attractive contemporary fresh charm.

Lignes épurées, un charme jeune, contemporain.





DIVANO 3 POSTI . L. 200 P. 87 H. 90 cm



COMPOSIZIONE T1 . L. 273 x P. 200 H. 90 cm



CIMABUE fisso . fixed . fixe

STRUTTURA

Struttura in multistrato di legno e altri derivati del legno

IMBOTTITURA

Poliuretano espanso a densità differenziate e falda di ovatta acrilica
 Seduta:
 molle insacchettate + gomma densità 30 kg x m³
 Spalliera:
 densità 21 kg x m³

SOSPENSIONE SEDUTA

Cinghie elastiche ad alta resistenza

RIVESTIMENTO

Tessuto:
 completamente sfoderabile
 Ecopelle:
 non sfoderabile

OPTIONAL

- piedino variante acciaio Puccini
- piedino variante in legno
- poggiatesta

STRUCTURE

Framework in poplar, fir and various derivatives

UPHOLSTERY

Polyurethane foam - various densities + acrylic wadding
 Seats:
 pocket springs + foam density 30 kg x m³
 Backrest:
 density 21 kg x m³

SEAT SUPPORT

High strength elastic straps

COVERING

Fabric:
 fully removable
 Artificial leather:
 partially removable

OPTIONAL EXTRA

- Puccini metal foot
- wood foot
- headrest

STRUCTURE

Sapin peuplier, multiplis et panneaux de particules

GARNISSAGE

Mousse polyuréthane expansé haute résilience
 Assises:
 ressorts ensachés + couche densité 30 kg x m³
 Dossier:
 densité 21 kg x m³ + couche acrylique

SUSPENSION D'ASSISE

Sangles élastiques haute résistance

REVETEMENT

Tissu:
 totalement déhoussable
 PVC:
 non déhoussable

OPTIONS

- Puccini pied metal
- pied bois
- appui-tête

divano . pouff / sofa . ottoman / canapé . pouf

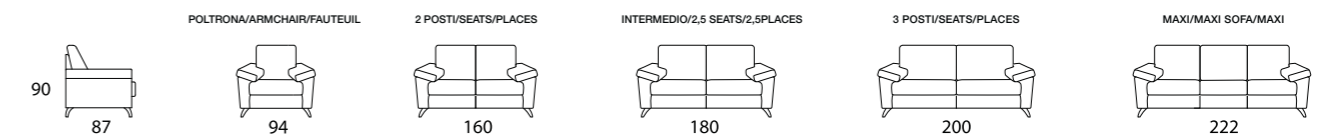

laterale sx-dx / element left-right / élément gauche-droite

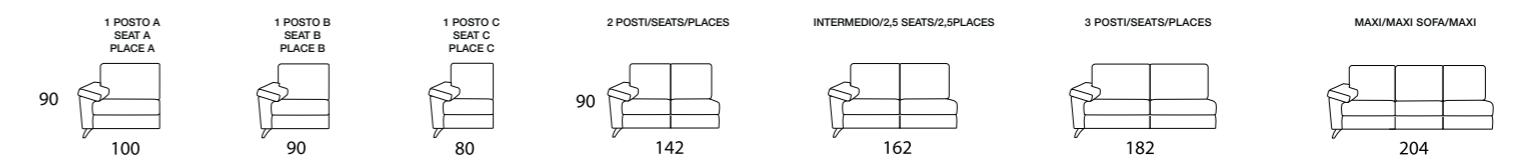

angolo terminale sx-dx corner terminal left-right angle terminal gauche-droite

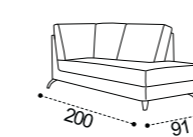

chaise longue sx-dx chaise longue left-right chaise-longue gauche-droite

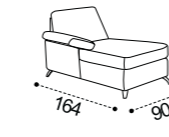

pouff / ottoman / pouf

POUFF SENZA CUSCINO
OTTOMAN WITHOUT CUSHION
POUF SANS COUSSIN

POUFF CON CUSCINO
OTTOMAN WITH CUSHION
POUF AVEC COUSSIN

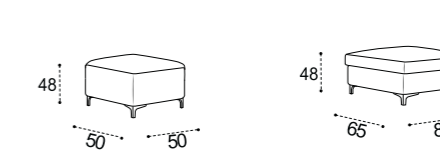

optional / optional extra / options



piedini in legno - colore wengé
wood feet - wengé colour
pieds en bois - couleur wengé



piedini in acciaio Puccini
Puccini metal feet
Puccini pied metal

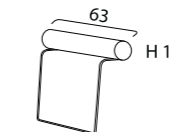

poggiatesta
headrest
appui-tête



molle insacchettate
pocket springs
ressorts ensachés

di serie / standard / standard

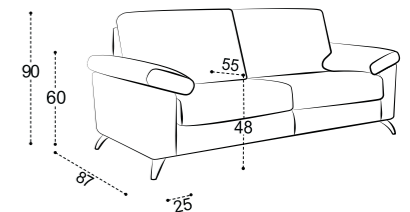

composizione C1 / composition C1 / composition C1

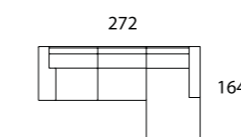

laterale 3PS+chaise longue
3PLCS side sofa+longue chair
terminal 3PL+chaise longue

composizione T1 / composition T1 / composition T1

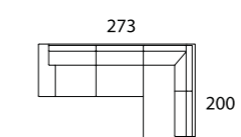

laterale 3PS+angolo terminale
3PLCS side sofa+corner terminal
terminal 3PL+angolo terminal

specificare lato penisola destra o sinistra
to specify right or left peninsula
spécifier si angle méridienne droite ou gauche

PASCOLI

Un look elegante e senza tempo ma anche un comfort importante. Un divano che non delude mai, in qualunque situazione lo si voglia inserire.

An elegant and timeless look together with great comfort. A couch that always fits into in any situation where you place it.

Un look élégant et intemporel mais avec un confort supérieur. Un classique.





DIVANO 3 POSTI . L. 207 P. 87 H. 95 cm

PASCOLI / 159

ELEGANZA E
COMFORT NELLA
LORO ESPRESSIONE
PIU' SEMPLICE



COMPOSIZIONE C1 . L. 276 x P. 164 H. 95 cm

PASCOLI / 161



COMPOSIZIONE A1 . L. 302 x P. 220 H. 95 cm

PASCOLI / 163

PASCOLI fisso/letto . fixed/bed . fixe/lit

STRUTTURA

Struttura in multistrato di legno e altri derivati del legno

IMBOTTITURA

Poliuretano espanso a densità differenziate e falda di ovatta acrilica
Seduta:
molle insacchettate + gomma densità 30 kg x m³
Spalliera:
densità 21 kg x m³

SOSPENSIONE SEDUTA

Cinghie elastiche ad alta resistenza

RIVESTIMENTO

Tessuto:
completamente sfoderabile
Ecopelle:
non sfoderabile

OPTIONAL

- piedino in argento
- letto DUO materasso H 12 cm

STRUCTURE

Framework in poplar, fir and various derivatives

UPHOLSTERY

Polyurethane foam - various densities + acrylic wadding
Seats:
pocket springs + foam density 30 kg x m³
Backrest:
density 21 kg x m³

SEAT SUPPORT

High strength elastic straps

COVERING

Fabric:
fully removable
Artificial leather:
partially removable

OPTIONAL EXTRA

- feet colour silver
- DUO bed mattress H 12 cm

STRUCTURE

Sapin peuplier, multiplis et panneaux de particules

GARNISSAGE

Mousse polyuréthane expansé haute résilience
Assises:
ressorts ensachés + couche densité 30 kg x m³
Dossier:
densité 21 kg x m³ + couche acrylique

SUSPENSION D'ASSISE

Sangles élastiques haute résistance

RETEMENT

Tissu:
totalement déhoussable
PVC:
non déhoussable

OPTIONS

- pieds coloris argent
- lit DUO matelas H 12 cm

poltrona . divano / armchair . sofa / fauteuil . canapé

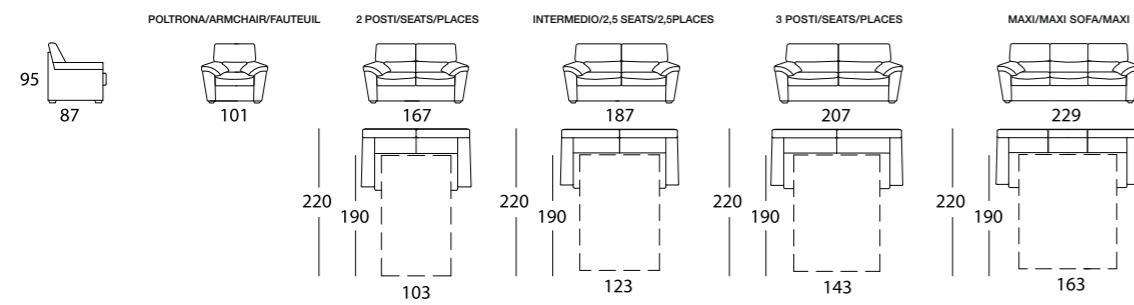

laterale sx-dx / element left-right / élément gauche-droite

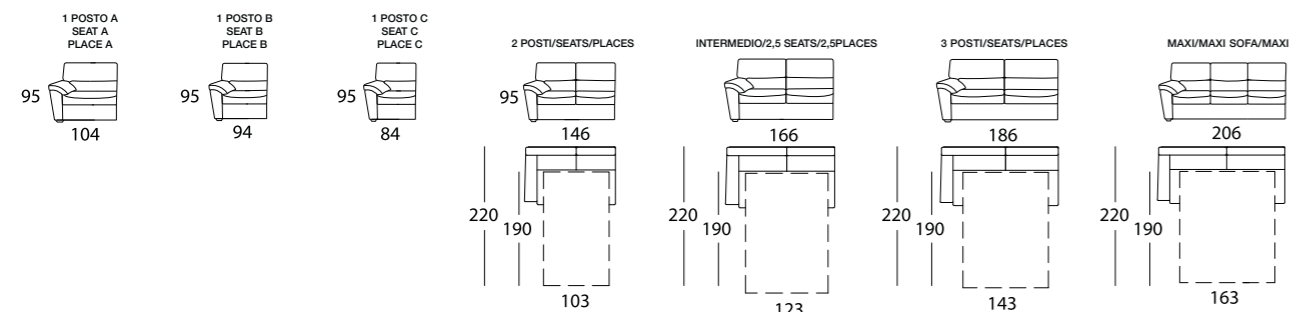

angolo terminale sx-dx / corner terminal left-right / angle terminal gauche-droite

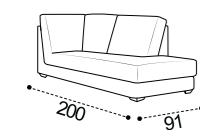

chaise longue sx-dx / chaise longue left-right / chaise longue gauche-droite

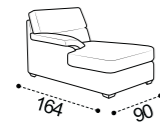

angolo / corner / angle

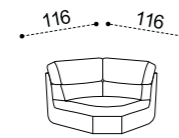

pouff / ottoman / pouf

POUFF SENZA CUSCINO
OTTOMAN WITHOUT CUSHION
POUF SANS COUSSIN HOCKER

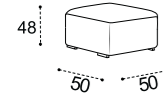

POUFF BIG CON CUSCINO
OTTOMAN BIG WITH CUSHION
POUF BIG AVEC COUSSIN

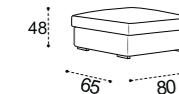

POUFF SMALL CON CUSCINO
OTTOMAN SMALL WITH CUSHION
POUF SMALL AVEC COUSSIN

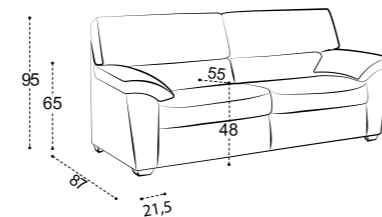
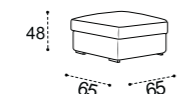

optional / optional extra / options



piedino in argento
feet colour silver
pieds coloris argent



letto "DUO" materasso H. 12 cm
"DUO" bed mattress H. 12 cm
lit "DUO" matelas H. 12 cm

di serie / standard / standard



molle insacchettate
pocket springs
ressorts ensachés

composizione A1 sx-dx / composition A1 left-right / composition A1 gauche-droite

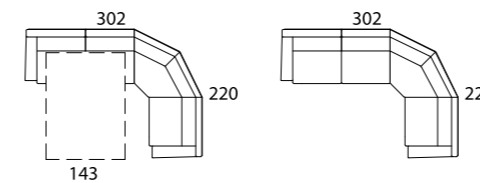

laterale 3PS letto+angolo+laterale 1 PS A
3PLCS side sofa+corner+side 1 PS A
terminal 3PL+angle+terminal 1 PS A

composizione C1 sx-dx / composition C1 left-right / composition C1 gauche-droite

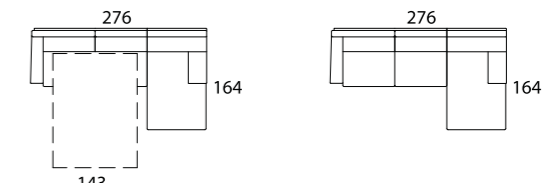

laterale 3PS letto+chaise longue
3PLCS side sofa+lounge chair
terminal 3PL+chaise longue

composizione T1 sx-dx / composition T1 left-right / composition T1 gauche-droite

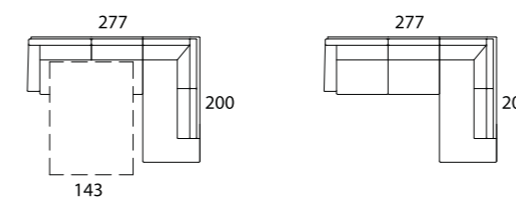

laterale 3PS+angolo terminale
3 PLCS side sofa+corner terminal
terminal 3PL+angle terminal

specificare lato penisola destra o sinistra
to specify right or left peninsula
spécifier si angle méridienne droite ou gauche

PUCCINI

Un design leggero e pulito ma ricco con i suoi profili che possono essere realizzati in contrasto di colore, creando personalizzazioni davvero esclusive. Le sedute a molle insacchettate offrono un maggior comfort e più durata nel tempo. Il piedino in acciaio cromato lo rende più fresco e accattivante.

Simple, clean design but its profiles, often in contrast colours, which create a really individual look. Pocket sprung seats offer better comfort and durability and the steel feet give it a more modern, fresh and attractive look.

Un design jeune et épuré, des assises avec ressorts ensachés qui donnent un super confort, des pieds en acier chromé et des finitions à contraste qui donnent une touche vraiment exclusive.





DIVANO 3 POSTI . L. 198 P. 87 H. 90 cm



DIVANO 3 POSTI . L. 198 P. 87 H. 90 cm _ DIVANO 2 POSTI . L. 158 P. 87 H. 90 cm

PUCINI / 171



COMPOSIZIONE B1 . L. 220 x 167 P. 87 H. 90 cm

PUCCINI fisso . fixed . fixe

STRUTTURA

Struttura in multistrato di legno e altri derivati del legno

IMBOTTITURA

Poliuretano espanso a densità differenziate e falda di ovatta acrilica
 Seduta:
 molle insacchettate + gomma densità 30 kg x m³
 Spalliera:
 densità 21 kg x m³

SOSPENSIONE SEDUTA

Cinghie elastiche ad alta resistenza

RIVESTIMENTO

Tessuto:
 completamente sfoderabile
 Ecopelle:
 non sfoderabile

OPTIONAL

- piedino variante in legno
- cuscino schienale banquette
- bordino su braccioli e cuscini arredo
- poggiatesta

STRUCTURE

Framework in poplar, fir and various derivatives

UPHOLSTERY

Polyurethane foam - various densities + acrylic wadding
 Seats:
 pocket springs + foam density 30 kg x m³
 Backrest:
 density 21 kg x m³

SEAT SUPPORT

High strength elastic straps

COVERING

Fabric:
 fully removable
 Artificial leather:
 not removable

OPTIONAL EXTRA

- wood foot
- back-cushion for banquette
- piping on arms and scatter cushions
- headrest

STRUCTURE

Sapin peuplier, multiplis et panneaux de particules

GARNISSAGE

Mousse polyuréthane expansé haute résilience
 Assises:
 ressorts ensachés + couche densité 30 kg x m³
 Dossier:
 densité 21 kg x m³ + couche acrylique

SUSPENSION D'ASSISE

Sangles élastiques haute résistance

REVETEMENT

Tissu:
 totalement déhoussable
 PVC:
 non déhoussable

OPTIONS

- pieds bois
- coussin dossier banquette
- passepoil sur accoudoirs et coussins déco
- appui-tête



divano . pouff / sofa . ottoman / canapé . pouf

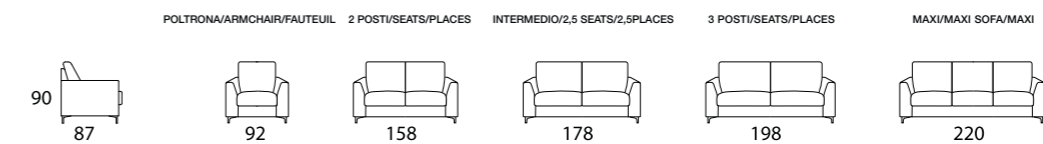

laterale sx-dx / element left-right / élément gauche-droite

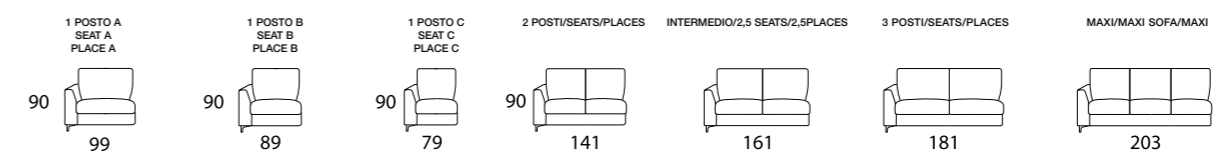

angolo terminale sx-dx corner terminal left-right angle terminal gauche-droite

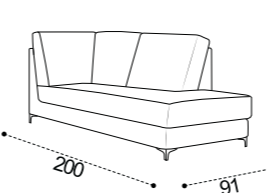

chaise longue sx-dx chaise longue left-right chaise longue gauche-droite

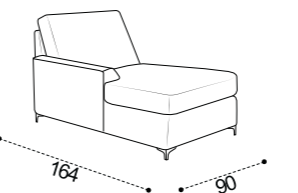

banquette

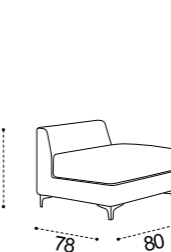

pouff / ottoman / pouf

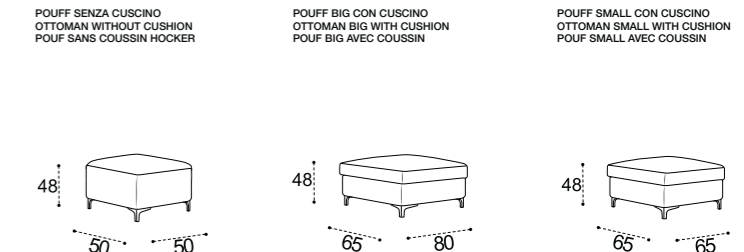

optional / optional extra / options



piedini in legno / wood feet / pieds bois
 bordino a contrasto / contrasting color piping / passepoil contrasté
 poggiatesta / headrest / appui-tête
 cuscino schienale banquette / back-cushion for banquette / coussin dossier banquette

di serie / standard / standard

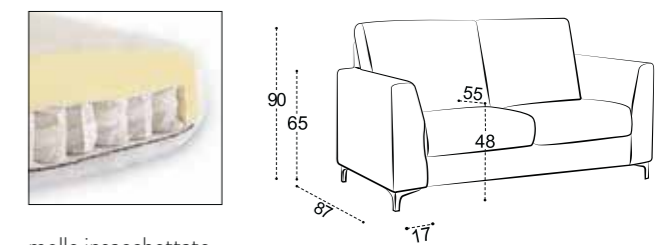

molle insacchettate / pocket springs / ressorts ensachés

composizione B1 / composition B1 / composition B1

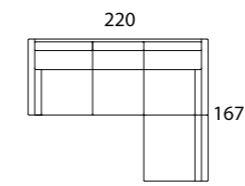

divano maxi+banquette / maxi sofa+banquette / canapé maxi+banquette

composizione C1 / composition C1 / composition C1

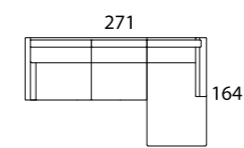

laterale 3PS+chaise longue / 3PLCS side sofa+lounge chair / terminal 3PL+chaise longue

composizione T1 / composition T1 / composition T1

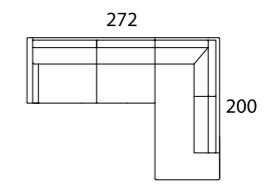

laterale 3PS+angolo terminale / 3PLCS side sofa+corner terminal / terminal 3PL+angle terminal

specificare lato penisola destra o sinistra
 to specify right or left peninsula
 spécifier si angle méridienne droite ou gauche

BOTTICELLI

Un divano pensato per i piccoli spazi con la sua profondità di solo 76 cm, ma allo stesso tempo un grande divano che mantiene un comfort elevato, giuste proporzioni ed un bel design.

Made for small spaces, with the right proportions and a depth of only 76 cm, but still a "big sofa" that gives great comfort and design.

Un canapé pour les petits espaces avec une profondeur de seulement 76 cm, un confort de qualité des bonnes proportions et un beau design.



SOLO 76 CENTIMETRI
DI PROFONDITÀ:
UN PICCOLO SPAZIO
PER UN GRANDE
COMFORT





DIVANO MAXI . L. 220 P. 76 H. 92 cm _ POLTRONA . L. 92 P. 76 H. 92 cm

BOTTICELLI / 181

BOTTICELLI fisso/letto . fixed/bed . fixe/lit

STRUTTURA

Struttura in multistrato di legno e altri derivati del legno

IMBOTTITURA

Poliuretano espanso a densità differenziate e falda di ovatta acrilica

Seduta:

molle insacchettate + gomma densità 30 kg x m³

Spalliera:

densità 21 kg x m³

SOSPENSIONE SEDUTA

Cinghie elastiche ad alta resistenza

RIVESTIMENTO

Tessuto:

completamente sfoderabile

Ecopelle:

non sfoderabile

OPTIONAL

- piedino variante argento

- cuscino schienale banquette

- bordino su braccioli e cuscini arredo

- letto TRIS materasso H. 7 cm

STRUCTURE

Framework in poplar, fir and various derivatives

UPHOLSTERY

Polyurethane foam - various densities + acrylic wadding

Seats:

pocket springs + foam density 30 kg x m³

Backrest:

density 21 kg x m³

SEAT SUPPORT

High strength elastic straps

COVERING

Fabric:

fully removable

Artificial leather:

not removable

OPTIONAL EXTRA

- feet colour silver

- back-cushion for banquette

- piping on arms and scatter cushions

- TRIS bed mattress H. 7 cm

STRUCTURE

Sapin peuplier, multiplis et panneaux de particules

GARNISSAGE

Mousse polyuréthane expansé haute résilience

Assises:

ressorts ensachés + couche densité 30 kg x m³

Dossier:

densité 21 kg x m³ + couche acrylique

SUSPENSION D'ASSISE

Sangles élastiques haute résistance

RETEMENT

Tissu:

totalément déhoussable

PVC:

non déhoussable

OPTIONS

- pieds coloris argent

- coussin dossier banquette

- passepoil sur accoudoirs et coussins déco

- lit TRIS matelas H. 7 cm

poltrona . divano / armchair . sofa / fauteuil . canapé

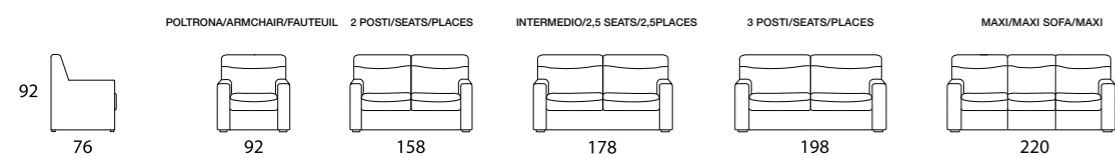

poltrona . divano / armchair . sofa / fauteuil . canapé

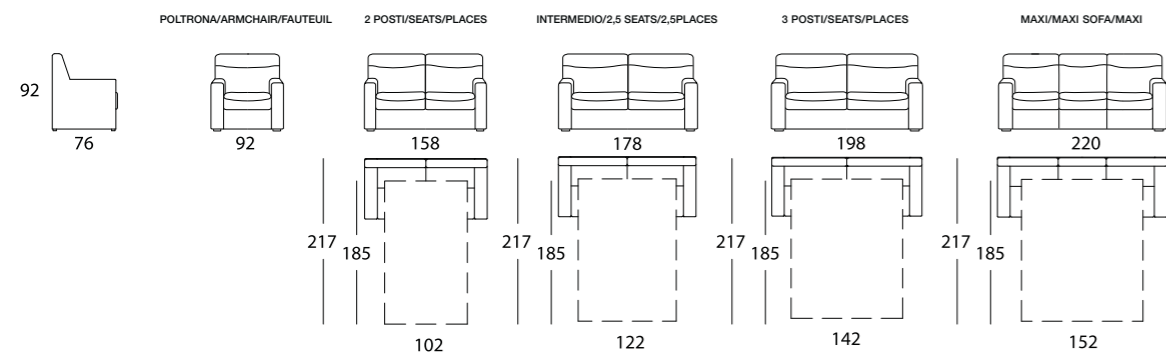

banquette

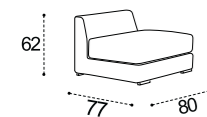

pouff / ottoman / pouf

POUFF SENZA CUSCINO
OTTOMAN WITHOUT CUSHION
POUF SANS COUSSIN

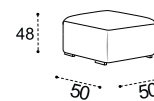

POUFF BIG CON CUSCINO
OTTOMAN BIG WITH CUSHION
POUF BIG AVEC COUSSIN

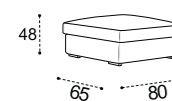

POUFF SMALL CON CUSCINO
OTTOMAN SMALL WITH CUSHION
POUF SMALL AVEC COUSSIN

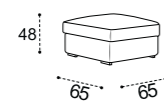

optional / optional extra / options



pedino in argento
feet colour silver
pieds coloris argent



bordino a contrasto
contrasting color piping
passepoil contrasté

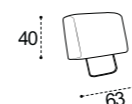

cuscino schienale banquette
back-cushion for banquette
coussin dossier banquette

di serie / standard / standard



molle insacchettate
pocket springs
ressorts ensachés

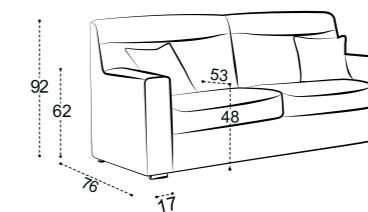

composizione B1 / composition B1 / composition B1

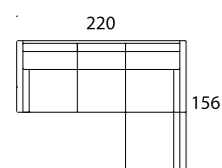

divano maxi+banquette
maxi sofa+banquette
canapé maxi+banquette

composizione B1 / composition B1 / composition B1

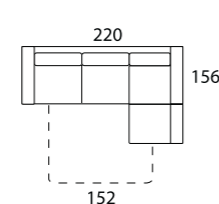

divano maxi letto+banquette
maxi sofa bed+banquette
canapé maxi lit+banquette